

FPG8601™/VLPC™
Operation and Maintenance Manual



High pressure liquids and gases are potentially hazardous. Energy stored in these liquids and gases can be released unexpectedly and with extreme force. High pressure systems should be assembled and operated only by personnel who have been instructed in proper safety practices.

© 2007 **DH Instruments, a Fluke Company** All rights reserved.

Information in this document is subject to change without notice. No part of this document may be reproduced or transmitted in any form or by any means, electronic or mechanical, for any purpose, without the express written permission of **DH Instruments, a Fluke Company** 4765 East Beautiful Lane Phoenix Arizona 85044-5318 USA.

DH Instruments makes sincere efforts to ensure the accuracy and quality of its' published materials; however, no warranty, expressed or implied, is provided. **DH Instruments** disclaims any responsibility or liability for any direct or indirect damages resulting from the use of the information in this manual or products described in it. Mention of any product or brand does not constitute an endorsement by **DH Instruments** of that product or brand. This manual was originally composed in English and was subsequently translated into other languages. The fidelity of the translation cannot be guaranteed. In case of conflict between the English version and other language versions, the English version predominates.

DH Instruments, DH, DHI, PG7000 and **CalTool** are trademarks, registered and otherwise, of **DH Instruments, a Fluke Company**.

Swagelok is a registered trademark of the Swagelok Company

Krytox is a trademark of the Dupont de Nemours Company

Document No. 550122e

060105

Printed in the USA



TABLE OF CONTENTS

TABLE OF CONTENTS III

TABLES VII

FIGURES VIII

ABOUT THIS MANUAL XI

1. INTRODUCTION 1

 1.1 OVERVIEW 1

 1.2 REQUIREMENTS 2

 1.3 SPECIFICATIONS 2

 1.3.1 GENERAL SPECIFICATIONS 2

 1.3.1.1 FPG8601 GENERAL SPECIFICATIONS 2

 1.3.1.2 AMBIENT AND INSTRUMENT CONDITION MEASUREMENTS 3

 1.3.1.3 PISTON-CYLINDER 3

 1.3.1.4 PRESSURE MEASUREMENT 3

 1.3.2 VLPC GENERAL SPECIFICATIONS 4

 1.4 FPG PLATFORM FRONT AND REAR PANELS AND VLPC FRONT AND REAR PANELS 5

 1.4.1 TERMINAL FRONT AND REAR PANELS 5

 1.4.1.1 FPG TERMINAL FRONT PANEL 5

 1.4.1.2 FPG TERMINAL REAR PANEL 6

 1.4.2 FPG PLATFORM FRONT VIEW 7

 1.4.3 FPG PLATFORM BACK VIEW 8

 1.4.3.1 VLPC REAR PANEL ASSEMBLY 9

2. FPG THEORY OF OPERATION 11

 2.1 OVERVIEW 11

 2.2 PISTON-CYLINDER 11

 2.3 LOAD CELL 13

 2.4 LUBRICATION PRESSURE 14

 2.5 VACUUM REFERENCE PRESSURE 14

 2.6 SIMPLIFIED FORMULA FOR CALCULATING DIFFERENTIAL PRESSURE 15

 2.6.1 REFERENCE LEVEL 16

 2.7 CORRECTIONS 16

 2.7.1 $\delta N1$ 16

 2.7.2 $\delta N2$ 16

 2.7.3 $\delta N3$ 17

 2.8 COMPLETE DIFFERENTIAL PRESSURE EQUATION 18

3. VLPC THEORY OF OPERATION 19

 3.1 OVERVIEW 19

 3.2 SUPPLY AND REGULATION 20

 3.3 FLOW CONTROL 20

 3.4 RANGE RESTRICTIONS 21

 3.5 CONTROL 21

 3.6 READY/NOT READY 22

4.	GETTING STARTED	23
4.1	OVERVIEW	23
4.2	INSTALLING FPG TOOLS	23
4.3	SETTING UP FPG TOOLS	24
4.4	BASIC FPG HARDWARE SETUP	25
4.5	SETTING UP THE PISTON-CYLINDER	26
4.6	CONNECTING THE FPG MANIFOLD AND VALVES	26
4.7	SETTING UP THE FPG FOR OPERATION	28
4.8	SETTING UP THE VLPC	29
4.9	INTRODUCING GAS TO THE FPG	29
4.10	CONNECTING A DUT.....	30
4.10.1	GAUGE MODE.....	30
4.10.2	ABSOLUTE MODE.....	30
4.10.3	ABSOLUTE DIFFERENTIAL MODE.....	31
4.11	CONNECTING THE DUT MANIFOLD	32
4.11.1	SETTING UP THE TURBO PUMP	33
4.11.2	CONNECTING THE ION GAUGE	33
4.12	CHANGING LUBRICATION GAS.....	34
4.12.1	PURGING THE LUBRICATING VOLUME WITH A NEW GAS	34
4.12.2	PURGING THE TEST PORT	35
5.	SYSTEM OPERATION.....	37
5.1	OVERVIEW	37
5.2	ZEROING THE FPG.....	37
5.2.1	ZERO CONDITION	37
5.2.2	STABILITY TEST.....	38
5.2.3	STORE ZERO DATA	38
5.3	INTERNAL CALIBRATION.....	38
5.3.1	DETERMINING CALIBRATION MASS VALUE	38
5.3.2	ACTIVATING NEW CALIBRATION	39
5.4	SETTING A MEASUREMENT MODE.....	41
5.5	USING A DUT WITH FPG TOOLS.....	41
5.6	ZEROING THE DUT MANIFOLD	42
5.7	CHANGING PRESSURE WITH THE VLPC.....	42
5.7.1	SETTING 0 PRESSURE	43
5.8	LOGGING DATA WITH THE FPG	43
5.9	SHUTTING DOWN THE FPG	44
6.	FPG TOOLS	45
6.1	OVERVIEW	45
6.2	MAIN MENU.....	46
6.3	MAIN DISPLAY	46
6.3.1	STATUS BAR	47
6.3.2	RUN DISPLAY	47
6.3.3	TARE DISPLAY	49
6.3.4	PLOT DISPLAY	50
6.3.4.1	CUSTOM PLOTS	50
6.3.4.2	STRIP CHARTS	51
6.3.5	LOGGED DATA	52
6.3.6	VLPC CONTROL	54
6.3.7	RUN DIAGNOSTICS.....	56
6.3.8	DUT MANIFOLD	59
6.4	TOOLBARS	60
6.4.1	WINDOW DISPLAY TOOLBAR	60
6.4.2	FUNCTIONS TOOLBAR.....	61
6.4.3	VALVE CONTROL.....	64

6.5	[RUN]	65
6.5.1	RUN MODE INITIALIZATION	65
6.5.2	[RUN MONITOR]	66
6.5.3	[RUN W/POINT LOG]	66
6.5.4	[RUN TEST SEQUENCE]	66
6.6	[CONFIG]	68
6.6.1	[SETTINGS]	68
6.6.2	[SYSTEM SETUP]	69
6.6.2.1	<SETUP>	69
6.6.2.2	<OPTIONS>	70
6.6.2.3	<DATA FILE>	72
6.6.3	[FPG CALIBRATION SETUP]	73
6.6.4	[INTERNAL LIMITS]	75
6.6.4.1	<SETUP>	75
6.6.4.2	<PRESSURE>	76
6.6.4.3	<TEMPERATURE>	77
6.6.4.4	<HUMIDITY>	78
6.6.4.5	<MASS>	79
6.6.4.6	<PURGE>	80
6.6.4.7	<VLPC>	81
6.6.5	[DUT SELECTION]	83
6.7	TEST SEQUENCE EDITOR	84
6.7.1	TOOLBAR	84
6.7.2	<POINTS> TABLE	85
6.7.3	[POINTS] TAB	87
6.7.4	<SEQUENCE> TAB	88
6.7.5	<CONTROL> TAB	89
6.7.6	<CYCLE> TAB	90
6.8	DUT DEFINITION EDITOR	91
6.8.1	TOOLBAR	91
6.8.2	DUT DEFINITION SELECTOR	92
6.8.2.1	[HEADER] TAB	93
6.8.2.2	[CORRECTION] TAB	94
6.8.2.3	[RANGE] TAB	95
6.8.2.4	[TOLERANCE] TAB	96
6.8.2.5	[READ] TAB	97
6.8.2.6	REMOTE COMMAND EDITOR	99
6.9	[UNITS]	102
6.9.1	[USER DEFINED UNITS]	102
6.9.2	[ABSOLUTE MODE], [GAUGE MODE]	103
6.9.2.1	[GAUGE MODE]	103
6.9.2.2	[ABSOLUTE MODE]	104
6.10	[CHANGE USER LEVEL]	104
6.11	[TOOLS]	105
6.11.1	[REMOTE COMMUNICATIONS]	105
6.12	INTERNATIONAL ISSUES	105
7.	PISTON-CYLINDER MAINTENANCE	107
7.1	OVERVIEW	107
7.2	REMOVING THE PISTON-CYLINDER FROM THE MOUNTING POST	109
7.3	REMOVING THE PISTON FROM THE CYLINDER	111
7.4	CLEANING THE PISTON AND CYLINDER	112
7.5	PUTTING THE PISTON INTO THE CYLINDER	113
7.6	INSTALLING THE PISTON-CYLINDER IN THE MOUNTING POST	114
7.7	RESTORING PISTON-CYLINDER LUBRICATION AND MOBILITY	115
7.7.1	OVERVIEW	115
7.7.2	PISTON CENTERING AND LUBRICATING METHODS	115
7.8	DETERMINING EFFECTIVE AREA	117
7.8.1	SETTING UP THE SYSTEM	117
7.8.2	GENERATING A PRESSURE	118
7.8.3	ADJUSTING THE NEEDLE VALVE	118
7.8.4	TAKING DATA (FOR EACH PRESSURE)	119
7.8.5	CALCULATING THE EFFECTIVE AREA	119

8.	GENERAL MAINTENANCE	121
8.1	OVERVIEW	121
8.2	REFILLING THE BUBBLER ON THE FPG	121
8.3	ZEROING THE VACUUM SENSOR	122
8.3.1	SET – UP.....	123
8.3.2	WARM-UP.....	123
8.3.3	TEST THE ZERO OF THE VACUUM SENSOR.....	123
8.4	CALIBRATING THE INTERNAL CALIBRATION MASS.....	125
8.4.1	INITIAL PREPARATIONS	125
8.4.2	REMOVE THE LOAD CELL COVER	125
8.4.3	REMOVE THE CALIBRATION MASS AND DRIVE.....	126
8.4.4	DETERMINE THE TRUE MASS VALUE OF THE INTERNAL CALIBRATION MASS	126
8.4.5	PUT THE MASS BACK INTO THE DRIVE ASSEMBLY	127
8.4.6	REATTACH THE LOAD CELL COVER	127
8.4.7	FINAL STEPS	127
8.5	MOUNTING POST PRT CALIBRATION.....	128
8.5.1	REMOVE THE PRTS	128
8.5.2	CREATE THE PRT CABLE ADAPTER	128
8.5.3	DETERMINE THE RO VALUE	129
8.5.4	ENTER THE RO VALUE INTO THE FPG TERMINAL.....	129
8.5.5	REATTACH THE PRTS TO THE FPG	130
8.6	PREPARING FOR STORAGE / SHIPMENT.....	130
8.6.1	FPG8601	130
8.6.2	VLPC.....	130
8.6.3	3-DUT MANIFOLD.....	131
9.	DATA FILES	133
9.1	OVERVIEW	133
9.2	POINT LOG DATA FILE (*.DAT).....	133
9.2.1	NAMING AND STORING DATA FILES	133
9.2.2	FILE FORMAT	133
9.3	INTERNAL CALIBRATION LOG FILE	133
9.4	SYSTEM ZERO LOG FILE	134
9.5	ERROR LOG FILE	134
10.	TROUBLESHOOTING	135
10.1	OVERVIEW	135
11.	APPENDIX	137
11.1	INTERNAL VALVES	137
11.2	UNIT CONVERSIONS.....	139
11.3	FPG8601 PRESSURE CALCULATIONS	140
11.3.1	COMPENSATED PRESSURES	140
11.3.2	DIFFERENTIAL PRESSURES	140
11.3.3	CORRECTION TERMS.....	140
11.3.4	THERMAL TRANSPIRATION CORRECTION	141
11.3.5	SAMPLE CALCULATIONS	144
11.3.5.1	GAUGE PRESSURE.....	144
11.3.5.2	ABSOLUTE PRESSURE	145
11.3.5.3	ABSOLUTE DIFFERENTIAL PRESSURE	146
11.3.5.4	INTERNAL CALIBRATION (KCAL).....	147
11.4	DECLARATION OF CONFORMITY.....	147
11.5	GROUNDING / ELECTRICAL SCHEMATICS.....	147
11.5.1	SYSTEM LEVEL GROUNDING.....	148
11.5.2	FPG GROUND DIAGRAM	149
11.5.3	VLPC POWER DIAGRAM	150
12.	WARRANTY STATEMENT	151
13.	GLOSSARY.....	153

TABLES



Table 1. Nominal VLPC Ranges	19
Table 2. Nominal VLPC Ranges, 15 kPa Unit	21
Table 3. Equipment for Basic FPG Hardware Setup	25
Table 4. Internal Calibration Results Options	40
Table 5. <Run Display> Labels	48
Table 6. <Tare Display> Labels	49
Table 7. <Custom Plot Properties> Tab Fields	51
Table 8. <Logged Points> Labels	53
Table 9. <VLPC Interface> Options	55
Table 10. <Diagnostics Display> Options	56
Table 11. <DUT Manifold> Color Scheme	59
Table 12. <DUT Manifold> Display	60
Table 13. Window Display Toolbar Options	61
Table 14. Functions Toolbar Option	61
Table 15. System Settings	68
Table 16. <System Setup><Setup> Options	69
Table 17. <System Setup><Options> Options	71
Table 18. <Options>, <Data File> Tab Fields	72
Table 19. <FPG8601 Calibration Setup> Options	74
Table 20. <Internal Limits> <Setup> Options	75
Table 21. <Internal Limits> <Pressure> Options	77
Table 22. <Internal Limits> <Temperature> Options	78
Table 23. <Internal Limits> <Humidity> Options	79
Table 24. <Internal Limits> <Mass> Options	80
Table 25. <Internal Limits> <Purge> Options	81
Table 26. <Internal Limits> <VLPC> Options	82
Table 27. <DUT Selection & I/O Setup> Options	83
Table 28. Test Sequence Editor, <Toolbar> Options	84
Table 29. Test Sequence Editor, <Points> Options	86
Table 30. Test Sequence Editor, <Points> Tab Fields	87
Table 31. Test Sequence Editor, <Sequence> Tab Fields	88
Table 32. Test Sequence Editor, <Control> Tab Fields	89
Table 33. Test Sequence Editor, <Cycle> Tab Fields	90
Table 34. DUT Definition Editor, <Toolbar> Features	91
Table 35. DUT Definition Editor, [Header] Tab Fields	93
Table 36. DUT Definition Editor, [Correction] Tab Fields	94
Table 37. DUT Definition Editor, [Range] Tab Fields	95
Table 38. DUT Definition Editor, [Tolerance] Tab Fields	97
Table 39. DUT Definition Editor, [Read] Tab Fields	98
Table 40. Piston-Cylinder Maintenance Equipment	107
Table 41. Effective Area Calculation Variables	119
Table 42. Sample Effective Area Spread Sheet	120
Table 43. Bubbler Maintenance Equipment	121
Table 44. Vacuum Reference Zeroing Equipment List	122
Table 45. Vacuum Reference Zeroing Equipment List	125
Table 46. Effective Area Calculation Variables	127
Table 47. PRT Calibration Cable Connections	128
Table 48. Effective Area Calculation Variables	129

Table 49. Troubleshooting Tips	135
Table 50. Internal Valve Descriptions	138
Table 51. Unit Conversion Factors	139
Table 52. FPG Defined Pressure Calculation Variables	142
Table 53. DHI Authorized Service Providers	151

FIGURES

Figure 1. FPG8601 Terminal Front Panel.....	5
Figure 2. FPG8601 Terminal Rear Panel	6
Figure 3. FPG Platform Front View	7
Figure 4. FPG Platform Back View	8
Figure 5. VLPC Rear Panel.....	9
Figure 6. Piston-cylinder Lubricating Flow	12
Figure 7. Internal Calibration Mass Alignment.....	13
Figure 8. FPG Forces.....	17
Figure 9. Gauge Mode VLPC Block Diagram	20
Figure 10. Absolute Mode VLPC Block Diagram.....	20
Figure 11. VLPC Ready Criterion	22
Figure 12. FPG8601 System Schematic.....	23
Figure 13. FPG8601 Manifold Connection.....	27
Figure 14. Internal Calibration Results Window.....	39
Figure 15. FPG Tools (Factory Mode)	46
Figure 16. <Status Bar>	47
Figure 17. <Run Display>	47
Figure 18. <Tare Display>.....	49
Figure 19. <Plot Data>	50
Figure 20. <Custom Plot Properties>.....	51
Figure 21. <Logged Points> Display.....	52
Figure 22. <VLPC Interface>	55
Figure 23. <Select VLPC Range>.....	55
Figure 24. <Diagnostics Display>	56
Figure 25. Window Display Toolbar	59
Figure 26. Window Display Toolbar	60
Figure 27. Manual Valve Control Toolbar	65
Figure 28. <Settings>.....	68
Figure 29. <System Setup><Setup> Tab	69
Figure 30. <System Setup><Interface>	71
Figure 31. <System Setup>, <Data File> Tab	72
Figure 32. <FPG8601 Calibration Setup>.....	74
Figure 33. <Internal Limits> <Setup>.....	75
Figure 34. <Internal Limits> <Pressure>.....	76
Figure 35. <Internal Limits> <Temperature>	78
Figure 36. <Internal Limits> <Humidity>	79
Figure 37. <Internal Limits> <Mass>	80
Figure 38. <Internal Limits> <Purge>	81
Figure 39. <Internal Limits> <VLPC>.....	82
Figure 40. <DUT Selection & I/O Setup>.....	83
Figure 41. Test Sequence Editor, <Toolbar>.....	84
Figure 42. Test Sequence Editor, <Test Points> Table.....	85
Figure 43. Test Sequence Editor, <Points> Tab.....	87
Figure 44. Test Definition Editor, <Control> Tab	89

Figure 45. Test Definition Editor, <Cycle> Tab	90
Figure 46. DUT Definition Editor, <Toolbar>	91
Figure 47. <DUT Selection> Tool	93
Figure 48. DUT Definition Editor, [Header] Tab	93
Figure 49. DUT Definition Editor, [Correction] Tab	94
Figure 50. DUT Definition Editor, [Range] Tab	95
Figure 51. DUT Definition Editor, [Tolerance] Tab	96
Figure 52. DUT Definition Editor, [Read] Tab	97
Figure 53. <Insert Special Character> Panel	99
Figure 54. <Initialization Commands Editor> Panel	100
Figure 55. <Read Commands Editor> Panel	101
Figure 56. <RS232 Settings> Panel	101
Figure 57. <User Defined Unit Setup>	102
Figure 58. <Remote Communications>	105
Figure 59. FPG8601 Piston Assembly in Mounting Post	108
Figure 60. Removing the Mounting Post	110
Figure 61. Removing the Piston	110
Figure 62. Alignment of the FPG piston in the cylinder	113
Figure 63. FPG8601 and PG7000 Cross Float Setup	117
Figure 64. FPG8601 Bubbling System	122
Figure 65. Calibration Mass Drive Assembly	126
Figure 66. PRT Calibration Cable Adaptor	128
Figure 67. FPG Internal Valve Configuration	137

NOTES



ABOUT THIS MANUAL

This manual provides the user with the information necessary to operate the FPG8601 system. It also includes a great deal of additional information provided to help you optimize system use and take full advantage of its many features and functions.

Realize that the numbers on the PC software screen captures and the VLPC range information are for example purposes only. In some cases the information required to setup the FPG is installed with FPG Tools. In other cases, the values must be entered into the FPG calibration setup (see Section 6.6.3).

Before using the manual, take a moment to familiarize yourself with the Table of Contents structure. All first time FPG users should read Section 2 for a comprehensive description of general operating principles. Section 8 provides maintenance and calibration information. Use the information in Section 10 to troubleshoot unexpected system behavior based on the symptoms of that behavior.

Certain words and expressions have specific meaning as they pertain to the FPG System. The Glossary (see Section 13) is useful as a quick reference for exact definition of specific words and expressions as they are used in this manual.



FOR THOSE OF YOU WHO “DON’T READ MANUALS”, GO DIRECTLY TO SECTION 4 TO SET UP YOUR FPG SYSTEM. THEN GO TO SECTIONS 5 and 6. THIS WILL GET YOU RUNNING QUICKLY WITH MINIMAL RISK OF CAUSING DAMAGE TO YOURSELF OR YOUR FPG. THEN... WHEN YOU HAVE QUESTIONS OR START TO WONDER ABOUT ALL THE GREAT FEATURES YOU MIGHT BE MISSING, GET INTO THE MANUAL!

Manual Conventions



(CAUTION) is used in throughout the manual to identify user warnings and cautions.



(NOTE) is used throughout the manual to identify operating and applications advice and additional explanations.

[] indicates direct function keys or menu options (e.g., **[Run]**).

< > indicates FPG Tools screen displays (e.g., **<FPG Pressure>**).

NOTES



1. INTRODUCTION

1.1 OVERVIEW

The FPG8601 (Force-Balanced Piston Gauge), VLPC (Very Low Pressure Controller) and FPG Tools (PC Based Software) are used in conjunction to act as a high precision pressure measurement and data acquisition system. Operator interaction with the FPG/VLPC and its extensive capabilities is accomplished through the PC based software from a computer via a standard RS232 port. FPG Tools also provides features to define a test sequence, read DUT's with a standard RS232 or IEEE-488 output, and log data to a data file.

FPG pressure is defined by using a high precision load cell to measure the force exerted on the effective area of a piston-cylinder (see Section 2). Instead of rotating the piston like other piston gauges, the FPG provides sensitivity between the piston and cylinder by maintaining a constant flow through the annular gap. This flow generates a centering force that prevents the piston from touching the cylinder during normal operation. Noise normally associated with rotation is therefore not present.

FPG platforms are designed to maximize metrological performance and ease of operation in both gauge and absolute modes. Many features are included to enhance the fundamental precision and stability of pressure measurements as well as simplifying use and reducing the operator influence on the measurements.

The VLPC generates low pressure in gauge and absolute modes (0 to 15 kPa). It is used to set and stabilize pressure as read by the FPG so that the VLPC/FPG combination can be used to set user specified target pressure values. The general operating principle of the VLPC is to generate a stable flow through one of a number of restrictions depending on the range of pressure to be controlled (see Section 3.4). The pressure drop across the restriction is the controlled differential pressure. Feedback from the FPG is used to dynamically readjust the flow to obtain the desired target pressure.

FPG Tools is the complete interface to both the FPG and the VLPC. An interface to all functional aspects of both instruments is provided by the software. FPG Tools uses three basic modes of operation to remotely interact with the FPG and VLPC: **[Run Mode]**, **[Run w/Point Logging]**, and **[Run Test Sequence]** (see Section 6.5). These modes respectively allow simple monitoring of pressure, monitoring of pressure with user dependant steps and data acquisition, and monitoring with defined test steps and data acquisition. A DUT can be used in any run mode for real-time error determination and/or data acquisition.

1.2 REQUIREMENTS

FPG Tools is a PC based application designed for 32 bit versions of Windows. The PC requirements stated below are necessary to maintain the minimum acceptable performance between the software and related hardware components.

- Windows XP, 98, NT service pack 4 or greater
- 500 MHz Pentium Processor or compatible
- 32 Mb of Ram
- 12 Mb free hard drive space

1.3 SPECIFICATIONS

1.3.1 GENERAL SPECIFICATIONS

1.3.1.1 FPG8601 GENERAL SPECIFICATIONS

Power Requirements:	85 to 264 VAC, 50 to 60 Hz, 60 VA consumption
Operating Temperature:	15 to 35 °C
Weight:	Instrument platform
FPG Platform	31.2 kg (61 lb)
FPG Terminal	1.4 kg (3 lb)
Dimensions:	
FPG Platform	53.4 cm H x 35.8 cm W x 35.5 cm D (21 in. H x 14.1 in. W x 14 in. D)
FPG Terminal	12 cm H x 15 cm W x 20 cm D (4.7 in. H x 5.9 in. W x 7.9 in. D)
Microprocessors:	
Instrument Platform	Motorola 68302
FPG Terminal	Hitachi 64180
Communication Ports:	
RS232	COM1: Host computer COM2: VLPC COM3: Not Used
IEEE-488.2	Not used
Maximum Pressure Ranges:	0 – 15 kPa Gauge and Absolute
Operating Media:	Gas: air or Nitrogen (N ₂)
Pressure Supplies:	Lubrication port: 700 - 850 kPa (100 - 120 psi), supply must remain constant ± 1 % to meet control specifications
Drive In Supply:	600 to 1000 kPa (90 to 150 psi) air
Maximum Overpressure Limit:	+20 kPa to –10 kPa (+3 to – 1.5 psi)
Pressure Connections:	
Lubrication Supply Port	1/8 in. NPT
Upper Test Port	KF16
Lower Test Port	KF16
Drive In Port	1/8 in. NPT
Vacuum Port	1/8 in. NPT
CE Conformance:	Not available
Driver Port (Ext Valve):	Not used

1.3.1.2 AMBIENT AND INSTRUMENT CONDITION MEASUREMENTS

Temperature:	<u>Lubrication Pressure</u>	<u>Piston-Cylinder</u>
	[°C]	[°C]
Range	0 to 40	0 to 40
Resolution	0.1	0.01
Accuracy	± 0.2	± 0.1
Relative Humidity:		
Range	5 to 95 %RH	
Resolution	1 %RH	
Accuracy	± 10 %RH	
Vacuum:		
Range	13 Pa	
Resolution	1 mPa	
Accuracy	± 20 mPa	
Ambient and Lubrication Pressure Sensor:		
Range	200 kPa	
Resolution	1 Pa	
Accuracy	± 0.1 kPa	

1.3.1.3 PISTON-CYLINDER

Cylinder Material:	Tungsten carbide
Piston Material:	Tungsten carbide
Nominal Diameter:	35 mm
Nominal Area:	980.5164 mm ²
Mounting System:	Non-rotative piston

1.3.1.4 PRESSURE MEASUREMENT

Resolution¹:	10 mPa
Precision Reproducibility²:	± 20 mPa
Uncertainty³:	Absolute: ± (25 mPa + 0.003 % of reading)
Standard Measurement:	Gauge and absolute differential: ± (20 mPa + 0.003 % of reading)

1. Resolution: The smallest variation in input detectable in output.
2. Reproducibility: Combined reproducibility of force measurement and long term stability of piston-cylinder effective area.
3. Standard Measurement Uncertainty: All sources of uncertainty under typical operating conditions are identified, quantified and combined following ISO/TAG4/WG3. The result is then rounded upwards to provide conservative global figures for the typical user in typical conditions of the maximum deviation from the true value of the pressure determined by the FPG8601 and the pressure actually present at the test point.

1.3.2 VLPC GENERAL SPECIFICATIONS

Power Requirements:	85 to 264 VAC, 47 to 60 Hz, 70 VA max. consumption
Operating Temperature Range:	15 to 35 °C
Storage Temperature Range:	- 20 to 70 °C
Weight:	41.6 kg (91.5 lb)
Dimensions:	30.5 cm H x 53.4 cm W x 50.5 cm D (12 in. H x 21 in. W x 19.9 in. D)
Microprocessor:	Motorola 68302, 16 MHz
Communication Ports:	
RS232	COM1: FPG COM2:: Not Used
IEEE-488.2	Not used
Control Specifications:	± 0.02 Pa + 30 ppm of range selected
Operating Medium:	Gas: air or Nitrogen (N ₂)
Pressure Supplies:	SUPPLY port: 700 - 850 kPa (100 - 120 psi), supply must remain constant ± 1 % to meet control specifications
Drive Air Supply:	600 to 1000 kPa (90 to 150 psi) air
Pressure Connections:	Test (Lo) 1/4 VCO Test (Hi) 1/4 VCO ATM 1/4 VCO Vacuum 3/8 VCO Supply 1/8 NPT F Drive 1/8 NPT F

1.4 FPG PLATFORM FRONT AND REAR PANELS AND VLPC FRONT AND REAR PANELS

1.4.1 TERMINAL FRONT AND REAR PANELS

1.4.1.1 FPG TERMINAL FRONT PANEL

The front panel assembly provides a 2 x 20 vacuum fluorescent display and a 4 x 4 membrane keypad for local user interface.

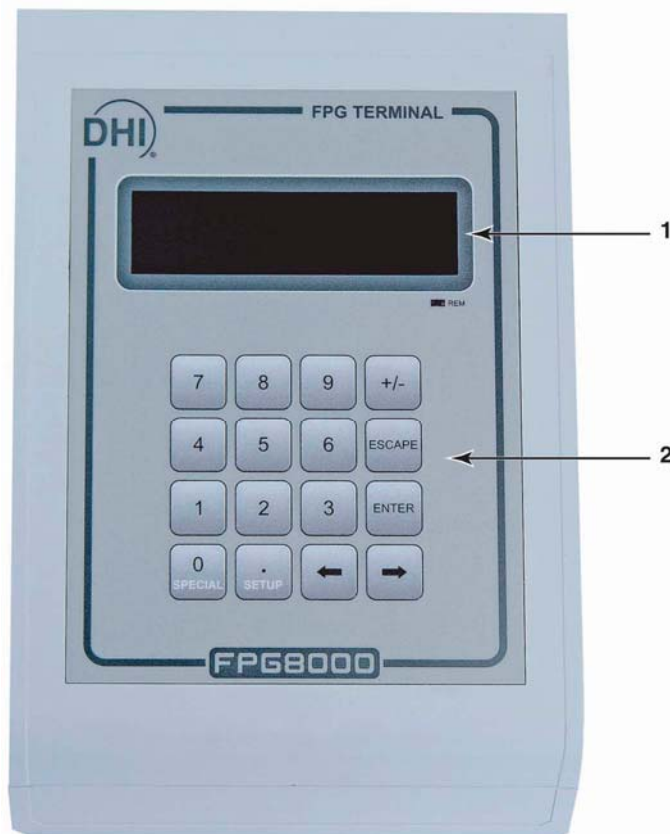

1. Display
2. Multi-Function Keypad

Figure 1. FPG8601 Terminal Front Panel

1.4.1.2 FPG TERMINAL REAR PANEL

The rear panel assembly provides the communications connection to the FPG platform and the power connection module.



- | | |
|---------------------|--|
| 1. Power Switch | 4. Connector for Cable to FPG (25 pin) |
| 2. Fuse | 5. Cooling Fan |
| 3. Power Receptacle | |

Figure 2. FPG8601 Terminal Rear Panel

1.4.2 FPG PLATFORM FRONT VIEW

The front of the FPG provides the connections to the VLPC, DUT and vacuum sensor. It also provides the electrical connection to the mounting post PRTs and vacuum sensor reading.

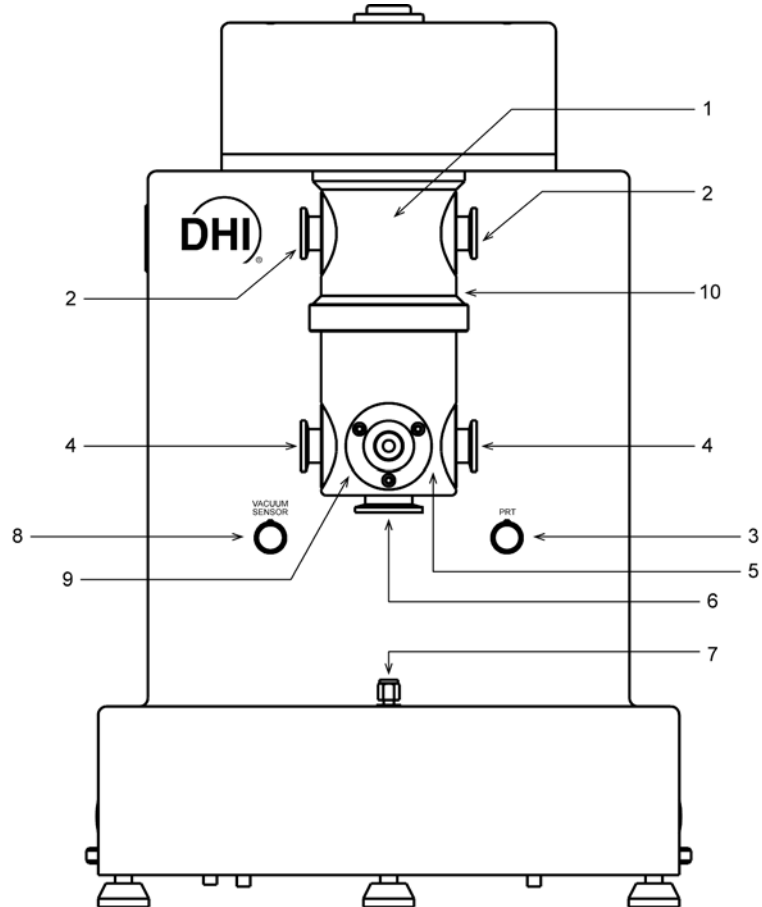

- | | |
|--------------------------------|----------------------------------|
| 1. Upper Mounting Post | 6. Vacuum Reference Port (KF-25) |
| 2. TEST+ (KF-16) | 7. Mounting Post Reference |
| 3. Mounting Post PRT Connector | 8. Vacuum Sensor Connector |
| 4. TEST- (KF-16) | 9. Vacuum Sensor Port |
| 5. Lower Mounting Post | 10. Reference Level |

Figure 3. FPG Platform Front View

1.4.3 FPG PLATFORM BACK VIEW

The FPG platform rear panels provide the connection to the FPG Terminal, remote communication connections and supply pressure connection ports.

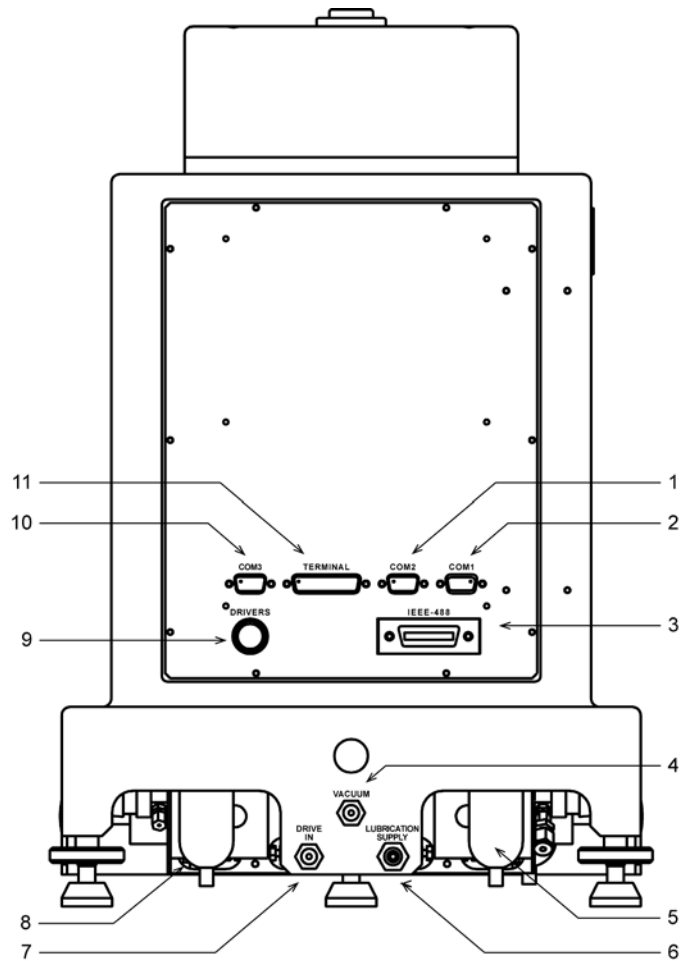

- | | |
|--|--|
| 1. COM2 (RS232) – VLPC | 6. Lubrication Supply |
| 2. COM1 (RS232) – Remote Host Communication | 7. Drive In |
| 3. IEEE-488 – Not Used | 8. Coalescing Filter |
| 4. Absolute Mode – Lubrication Pressure Vacuum | 9. Drivers Option Connector - Not Used |
| 5. Bubbler | 10. COM3 (RS232) – Not Used |
| | 11. FPG Terminal Port |

Figure 4. FPG Platform Back View

1.4.3.1 VLPC REAR PANEL ASSEMBLY

The rear panel assembly provides pressure connections, communications interfaces, the power ON/OFF module and product labeling. Pressure fittings are internally secured to prevent loosening when making and breaking connections.

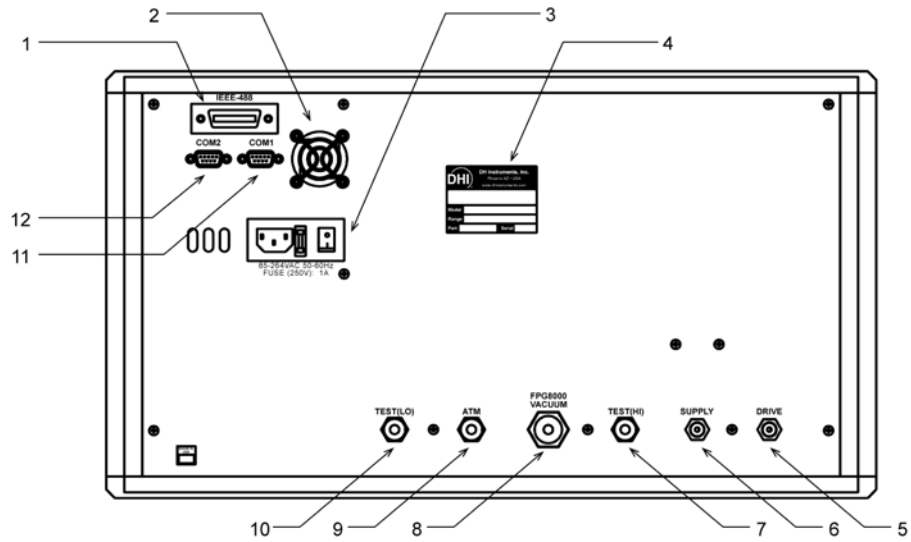

- | | |
|---------------------------------------|-------------------------------------|
| 1. IEEE-488 Connector – Not Available | 7. Pressure Connection – Test (Hi) |
| 2. Fan | 8. Pressure Connection – FPG Vacuum |
| 3. Power Switch | 9. Pass Through – ATM Ref |
| 4. Label, Product | 10. Pressure Connection – Test (Lo) |
| 5. Pressure Connection – Drive | 11. COM1 (RS232) – To FPG |
| 6. Pressure Connection – Supply | 12. COM2 (RS232) – Not Used |

Figure 5. VLPC Rear Panel

NOTES



2. FPG THEORY OF OPERATION

2.1 OVERVIEW

The FPG measures low gauge and absolute pressure by using a load cell to measure the force on the effective area of a 35 mm piston. A measurement mode specific lubricating pressure is applied to the annular gap of the piston-cylinder to provide a centering force on the piston. Compensation for the effects of the lubrication pressure on the load cell and piston are determined during the manufacturing process. The output of the load cell combined with the force components associated with the lubrication pressure determines the total force on the piston. This force divided by the temperature corrected effective area of the piston determines the differential pressure of the FPG.

In gauge mode, the FPG differential pressure is equivalent to the gauge pressure of the system since the lower port of the FPG is exposed to atmosphere. In absolute mode, the lower port of the FPG is connected to vacuum. Because of the lubricating flow, a perfect vacuum can never be achieved; therefore a high precision low range vacuum reference sensor is used to measure the residual vacuum pressure. This pressure is applied to the FPG differential pressure to obtain the final system absolute pressure. Absolute differential operation of the FPG is the same as absolute mode operation without the use of the vacuum reference sensor.

To support automatic zeroing and calibration of the FPG the mounting post assembly contains several pneumatic valves that are automatically controlled by FPG Tools. Many internal sensors are also present to verify that the FPG is operating in the required conditions and to make pressure buoyancy corrections.

2.2 PISTON-CYLINDER

The FPG uses a 35 mm diameter, tungsten carbide piston-cylinder designed with a pressure to mass conversion coefficient of 10 kPa/kg. The cylinder has a conical shape on its interior surface to generate a centering force on the piston when a lubrication pressure is applied in the annular gap through the center of the cylinder (see Figure 6). The non-rotating piston is connected to the load cell by a multi degree of freedom mechanical assembly located at its center of gravity. This allows the piston to center itself in the cylinder under the influence of the lubricating pressure. As a result, the piston is perfectly mobile, making no contact with the cylinder.

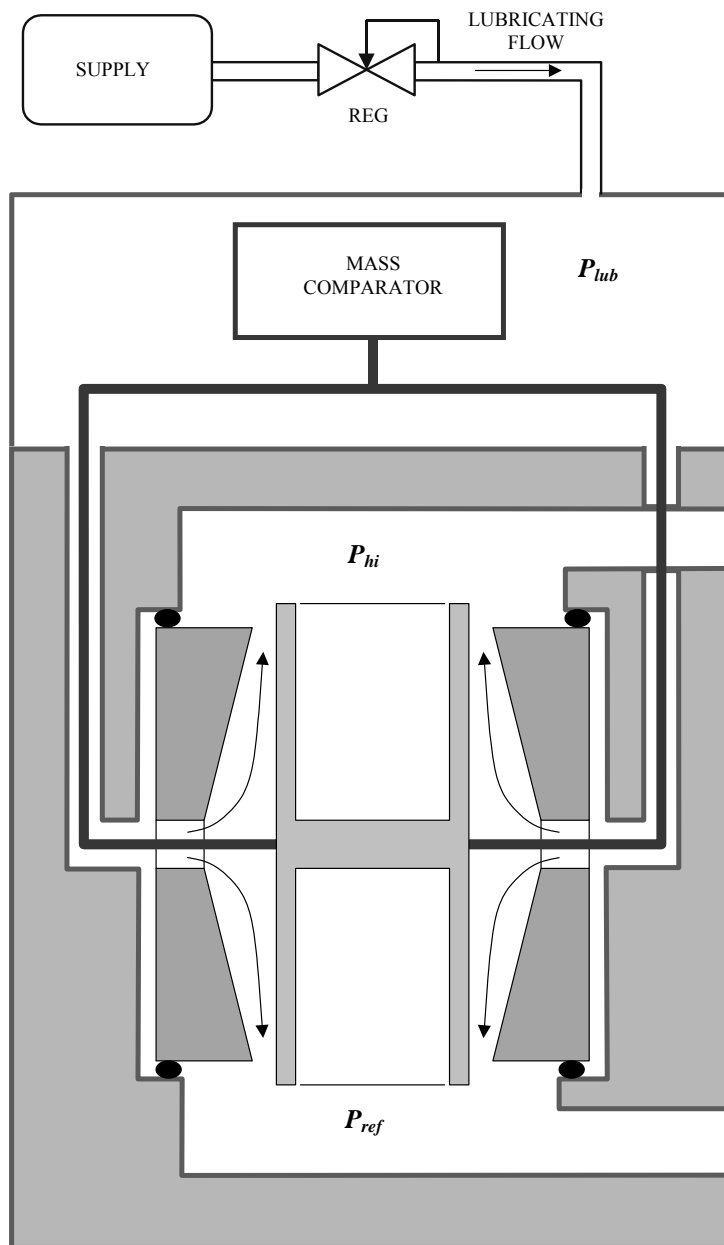

Figure 6. Piston-cylinder Lubricating Flow

The piston-cylinder resides in the mounting post that provides upper and lower measurement chambers equipped with high pressure (P_{hi}) and low pressure (P_{ref}) connections at the two extremities of the piston-cylinder. The high pressure port is the measurement port of the FPG. The low pressure port is considered the reference port of the system. When the port is exposed to atmosphere, the FPG will read gauge pressure. If the port is exposed to vacuum, the FPG will measure absolute differential pressure. The measured value of the low pressure port must be applied to the FPG differential pressure to get an absolute pressure.

2.3 LOAD CELL

The load cell has a measurement capacity equivalent to 2 300 g with a resolution of 1 mg. A force equivalent to 1 500 g is used for the measuring range. The rest of the measurement capacity is used to compensate for the mass of the piston and its carriage assembly.

During the manufacturing process, the load cell is calibrated and linearized within the required specifications. Load cell accuracy is maintained by the ability to frequently zero null force error, and by making slope corrections using an internal calibration mass. The FPG is specifically designed to allow the internal calibration mass to be measured in perfect alignment with the piston and cylinder (see Figure 7). The mass value of the internal calibration mass is accurately determined and stored in FPG Tools as a true mass value. When the mass is lowered in the operating conditions of the FPG, a correction factor is determined to cause the buoyancy corrected output of the load cell to be equivalent to this true mass value. Sensors internal to the FPG measure pressure, temperature and humidity around the load cell to make the buoyancy correction. Since zeroing and running the internal calibration are integral parts of the FPG, pneumatic valves are included with the FPG to allow the system to automatically set the necessary conditions to perform each task.

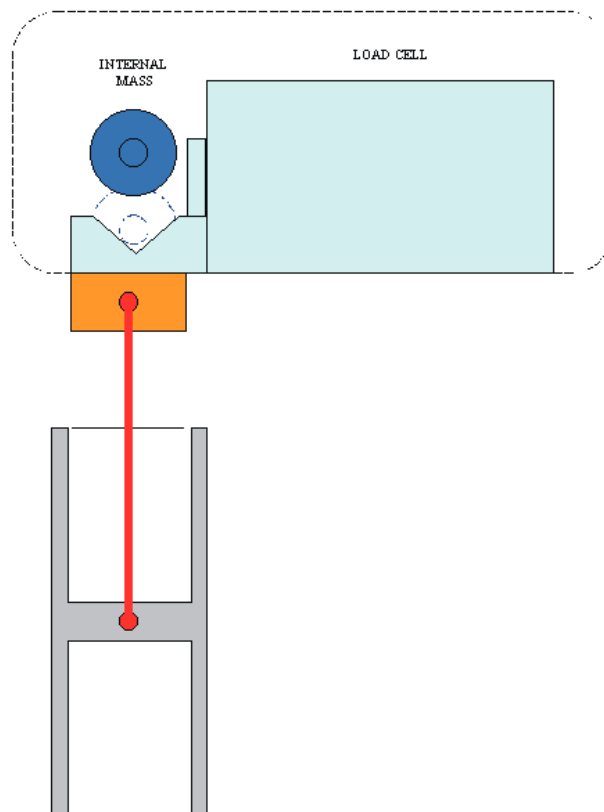

Figure 7. Internal Calibration Mass Alignment

The FPG configuration subjects the load cell to the lubricating pressure which significantly differs from typical atmospheric conditions. The optimum environmental conditions of the balance are specified by the manufacturer as temperature between 10 and 30 °C with relative humidity of 40 to 70 %. Typical laboratory conditions yield the necessary temperature range. The humidity is, however, controlled to approximately 50 % by a bubbling system internal to the FPG. FPG Tools will display a warning message if these conditions change beyond these limits. Low humidity values cause electrostatic effects on the load cell which have adverse influence on the zero stability of the load cell.

2.4 LUBRICATION PRESSURE

Two different values of lubricating pressure are used depending on whether the FPG is working in gauge or absolute measurement modes. These two pressures are supplied by two independent regulators which can be connected by valves depending on the measurement mode. In gauge measurement mode, the nominal lubricating pressure value is 140 kPa absolute which is about 40 kPa gauge. In absolute measurement mode, the nominal lubricating pressure is 40 kPa absolute. The absolute mode lubricating pressure reduces the lubricating flow which allows the reference vacuum or back pressure to be less than a Pascal with most standard vacuum pumps. Higher power vacuum pumps can be used to greatly reduce this pressure.

The lubrication pressure affects buoyancy forces on the load cell and the piston-cylinder as well as creating a change in the dragging force on the piston-cylinder. The buoyancy effect is characterized during the manufacturing process by varying the lubrication pressure and recording the change in load cell output relative to the change in lubrication pressure. The drag effect is determined by maintaining a constant lubrication pressure and changing the reference (see Section 2.7). Each time the FPG is zeroed, these effects are also set to zero. Therefore, changes in these forces are only due to changes in the lubrication pressure and reference pressure since the last zero. A high quality pressure regulator built into the FPG prevents this pressure from changing significantly when proper system pressure is applied. As a result, the influence of the lubrication pressure on the FPG is maintained at a minimum.

The FPG is intended to be used in ambient conditions which means that the gas present in the upper and lower measurement chambers is ambient air. It is therefore desirable to use air as the lubricating medium. This avoids gas mixtures in the measurement chamber. However, FPG Tools supports N₂ as a lubrication gas. Prior to changing gases, the system must be thoroughly purged. This includes the lubricating volume and the test and reference ports of the FPG. Lack of knowledge of the constitution of the test gas complicates the calculation of density needed to make fluid head corrections.

2.5 VACUUM REFERENCE PRESSURE

The FPG8601 inherently measures differential pressure. When the lower mounting post is exposed to atmosphere, the FPG measures gauge pressure. If the lower mounting post is exposed to a vacuum, the FPG measures absolute differential pressure. To measure absolute pressure, the residual vacuum pressure in the lower mounting post must be added to the FPG differential pressure. As a result, a high accuracy low range sensor is included with the FPG to define absolute pressure.

Depending on the vacuum pumps used, the residual vacuum pressure will be less than 1 Pa. At this pressure, span error in the vacuum sensor does not significantly impact the overall uncertainty of the FPG. A 0.5 % span error at 1 Pa results in a .005 Pa error. However, zero offset in the sensor is directly transferred to the zero offset of the FPG. Therefore, the zero of the sensor should be checked frequently (see Section 8.3). A pneumatic valve is provided to isolate the vacuum reference sensor when the FPG is not under vacuum. This helps to reduce zero drift by avoiding the shock associated with a change from vacuum to atmosphere. FPG Tools automatically isolates the sensor depending on the current mode of operation.

2.6 SIMPLIFIED FORMULA FOR CALCULATING DIFFERENTIAL PRESSURE

The calculation of differential pressure is made following the basic formula:

$$\Delta P = F/A_{\text{eff.}}(\theta)$$

VARIABLE	DEFINITION
ΔP	Differential pressure between the upper and lower chambers in Pa.
F	Force measured by the load cell in counts (1 count = 1 mg).
A_{eff.}(θ)	Effective area of the piston-cylinder at the operating temperature, θ . The value is expressed in m ² .

The force, F, measured by the load cell when it displays a number of counts, N, can be calculated using a calibration coefficient, K_{cal}, following:

$$F = K_{\text{cal.}} \cdot N$$

VARIABLE	DEFINITION
K_{cal.}	Calibration coefficient of the load cell. This value contains any necessary slope correction for the load cell determined by the internal calibration (see Section 5.3). The air density and local gravity present at the time the calibration was performed are also quantified by this value. The calibration factor is expressed in Newtons/ Count (1 count = 1 mg).
N	Number of counts output by the load cell representing the force measured. One count represents the force corresponding to a mass of 1 mg loaded on the load cell under the calibration conditions.

The effective area of the piston-cylinder at temperature θ , can be expressed using its value at 20 °C and the linear thermal expansivity of the piston and the cylinder materials following:

$$A_{\text{eff.}}(\theta) = A_{\text{eff.}}(20^{\circ}\text{C}) \cdot [1 + (\alpha_p + \alpha_c) \cdot (\theta - 20)]$$

VARIABLE	DEFINITION
α_p	Linear thermal expansivity of the piston in K ⁻¹ .
α_c	Linear thermal expansivity of the cylinder in K ⁻¹ .

The piston and the cylinder are made of tungsten carbide therefore the thermal expansion coefficients are the same; $\alpha_p + \alpha_c = 9 \cdot 10^{-6} \text{ K}^{-1}$. FPG Tools provides a single entry value for this combined effect in the FPG calibration setup (see Section 6.6.3).

The simplified formula for the calculation of the differential pressure can therefore be expressed as:

$$\Delta P = K_{\text{cal.}} \cdot N / A_{\text{eff.}}(20^{\circ}\text{C}) \cdot [1 + (\alpha_p + \alpha_c) \cdot (\theta - 20)]$$

In gauge measurement mode, the differential pressure is defined as being the difference between the pressure in the upper chamber at the reference level of the mounting post and the pressure at the corresponding level in the ambient air.

In absolute measurement mode, the differential pressure is defined as being the difference between the pressure in the upper chamber at the reference level of the mounting post and the reference vacuum in the lower chamber measured by the capacitance diaphragm gauge.

The reference pressure is defined as the pressure surrounding the piston when the load cell is in a zero condition with the upper and lower chambers in by-pass condition. Therefore, the reference pressure is atmospheric pressure in gauge mode and vacuum in absolute mode.

2.6.1 REFERENCE LEVEL

The reference level of the mounting post is defined as the height at which a variation of density in the upper chamber will not affect the differential pressure measurement. This position depends on the internal geometry of the piston in the upper chamber, in this case, the piston is hollow. The position of the reference level of the FPG is 25 mm above the center of the piston. This is approximately the bottom of the upper mounting post (see Figure 3).

2.7 CORRECTIONS

The simplified formula of differential pressure is valid only in the special case where the conditions of the gas surrounding the load cell and the piston do not change from the time the mobile assembly (made up of the piston and its carriage) is zeroed and the time the differential pressure measurement is made. Although the FPG is designed to keep these conditions very stable, it cannot be assumed that they are constant. Therefore corrections are made to compensate for the associated force changes. The force of the differential pressure acting on the piston is affected by three different quantities: $\delta N1$, $\delta N2$ and $\delta N3$. FPG Tools displays these corrections real time on the **<Diagnostics Display>** windows (see Section 6.3.7). Figure 8 displays each of these quantities. This figure shows the forces on the system, both at tare and in operation after tare. N_0 represents the force on the load cell at the time of tare. N represents for force on the load cell in operation after tare.

Since the effects of buoyancy and drag at the time of tare are included when the FPG is zeroed, it is only necessary to correct for changes in these forces due to changes in conditions after the time of tare (zero). A δ precedes each of the corrections because they are derived from changes of conditions since the last tare. FPG Tools provides warnings to prevent significant changes in each of the correction factors in order to limit the magnitude of overall correction (see Section 6.6.4).

2.7.1 $\delta N1$

If the lubricating pressure which surrounds the load cell, the piston carriage and the piston changes after the tare is executed due to drift of the lubricating pressure regulator or temperature of the lubricating gas, the corresponding change in buoyancy force will affect the force on the load cell. This change in force is quantified by $\delta N1$. $\delta N1$ is a function of the buoyancy force coefficient, K_b , which is determined experimentally by varying the lubrication pressure and subtracting the effect due to changes in the drag force (see Section 2.7.2). $\delta N1$ is calculated using K_b and the change of the lubrication pressure since the last system zero (see Section 11.3.3).

2.7.2 $\delta N2$

Due to a small amount of asymmetry of any piston-cylinder assembly, the difference between the lubricating pressure and the reference pressure surrounding the piston creates a net viscous drag force that acts on the piston. If this differential pressure changes after the tare has been executed the drag force changes and the force on the load cell will be affected.

To determine $\delta N2$, a drag force coefficient, K_d , is determined experimentally. K_d is determined by varying the reference pressure while holding the lubrication pressure constant. Subtracting the buoyancy changes due to the change in reference pressure (see Section 2.7.3),

the remaining effect is the change in force due to drag on the piston. δN_2 is calculated using K_d and the change in the difference between the lubrication pressure and the reference pressure (see Section 11.3.3).

2.7.3 δN_3

Buoyancy due to the reference pressure gas that surrounds the piston exerts a force that acts on the piston. If the FPG reference pressure changes after the tare is executed, the corresponding change in the buoyant force affects the force on the load cell. In absolute mode the reference pressure is on the order of a few Pascal. Buoyancy effects related to changes in such a low pressure are insignificant. Therefore, $\delta N_3 = 0$ for absolute mode.

In gauge mode the reference pressure is atmosphere. Buoyancy effects due to changes in atmosphere can have a measurable effect on the output of the FPG. Like the other correction terms, δN_3 quantifies the change in buoyancy due to the change in atmosphere. Typically atmospheric changes are quite small so the change in buoyancy will also be small. The effect of δN_3 is most apparent when the FPG is zeroed in gauge mode, then the system is changed to absolute mode without re-zeroing (not a recommended practice). The change in reference pressure is equal to one atmosphere. The change in buoyancy force associated with this large change is the correction. Since zeroing in each mode of operation is standard procedure for the FPG, this extreme situation does not occur.

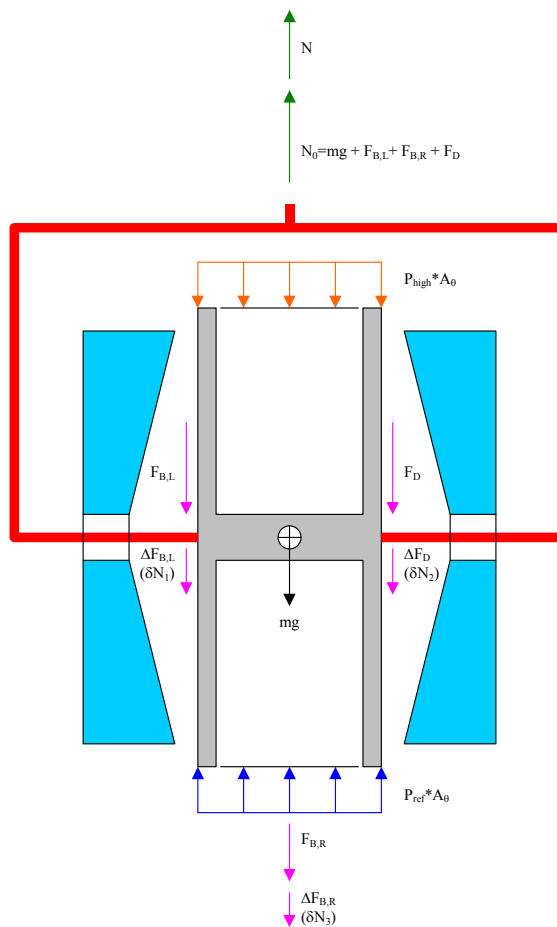

Figure 8. FPG Forces

2.8 COMPLETE DIFFERENTIAL PRESSURE EQUATION

The combination of all corrections along with the simplified pressure equation yields the complete differential pressure equation for the FPG. An exploded view of all FPG calculations is detailed in Section 11.3.

$$\Delta P = K_{\text{cal.}} \cdot (N + \delta N_1 + \delta N_2 + \delta N_3) / [A_{\text{eff.}}(20^{\circ}\text{C}) \cdot [1 + (\alpha_p + \alpha_c) \cdot (\theta - 20)]]$$

In gauge measurement mode, this differential pressure is equal to the gauge pressure of the FPG. In absolute mode, the residual vacuum pressure measured by the vacuum reference sensor is applied to the calculated differential pressure to obtain the absolute pressure of the FPG.



3. VLPC THEORY OF OPERATION

3.1 OVERVIEW

The VLPC (in conjunction with the FPG) generates low pressures in gauge and absolute modes (0 to 15 kPa). The purpose of the VLPC is to set and stabilize pressure as read by the FPG so that the VLPC/FPG combination can be used to set user specified target pressures. The **[Config]**, **[System Setup]**, **<Enable VLPC>** option must be checked to allow FPG Tools to control all aspects of the VLPC based (see Section 6.6.2.1).

The general operating principle of the VLPC is to generate a stable flow through one of a number of restrictions depending on the range of pressure to be controlled. The pressure drop across the restriction is the differential pressure in gauge mode. In absolute mode, the pressure at the high pressure sense is the absolute pressure generated.



The VLPC is a very sensitive pressure controller. In gauge mode, subtle changes in ATM may affect the control of the VLPC. Shutting doors, turning on air conditioning, etc. may cause momentary fluctuations in the controlled pressure. Absolute mode is not sensitive to these conditions. The effect on control is more significant as the volume attached to the upper mounting post of the FPG increases. If atmospheric disturbances cannot be avoided, a direct connection of a DUT to the FPG that minimizes the volume will optimize control. Regardless, because the FPG and DUT(s) are seeing the same pressure, the effect of fluctuations can be minimized by increasing the averaging time when taking data.

Based on pressure readings from the FPG, the VLPC can control pressures within ± 0.020 Pa + 30 ppm of the range selected. Use **[Config]**, **[Settings]** (see Section 6.6.1) to define the actual pressure ready criterion. The range maximums (Pa) are approximately defined in Section 6.6.1. The vacuum pump used for absolute mode actually defines the lowest absolute control range. This table was generated using a D16b vacuum pump.

Table 1. Nominal VLPC Ranges

ABSOLUTE (Pa)	GAUGE (Pa)
5	15
150	150
1 500	1 500
5 000	3 000
15 000	15 000

The block diagrams below illustrate absolute and gauge mode pressure and flow.

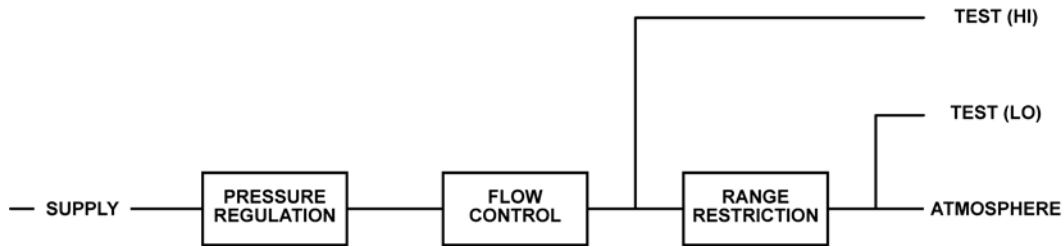

Figure 9. Gauge Mode VLPC Block Diagram

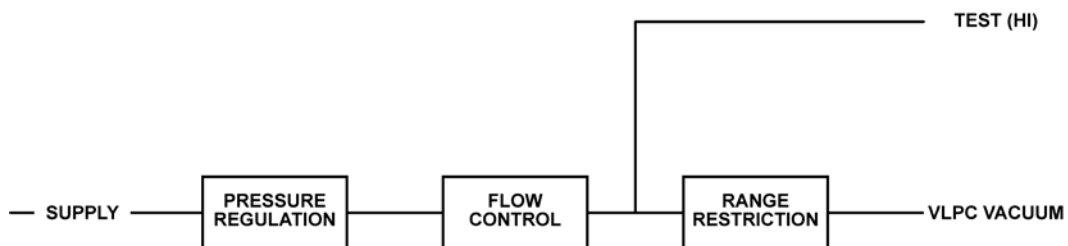

Figure 10. Absolute Mode VLPC Block Diagram

The breakdown of the system is in the following areas: supply and regulation, flow control, range restrictions, connections and control.

3.2 SUPPLY AND REGULATION

The FPG and VLPC must use the same gas medium. Typically this is bottled N₂, however dry air is also supported. There are additional considerations for initial setup and operation of the FPG in gauge mode with a nitrogen source. Whenever changing gas mediums, the FPG and VLPC must be thoroughly purged (see Section 4.12).

The supply gas to the VLPC must be clean, dry air between 700 and 840 kPa gauge (100 and 120 psig), with stability of $\pm 1\%$. For the VLPC to provide stable pressures, the inlet pressure to the flow controllers must be stable. After passing through a 0.5 micron filter, the VLPC supply is regulated down to 200 kPa gauge by a large diaphragm 350 kPa Tescom regulator. The output of the Tescom regulator feeds an LNI regulator set at 100 kPa above the LNI reference. The LNI reference is downstream of the range restrictions – a location that is effectively atmosphere for gauge control and vacuum for absolute control. A 100 kPa differential pressure has been found to produce the most stable flow across the MFCs.

3.3 FLOW CONTROL

The flow is controlled by two mass flow controllers (MFC) in parallel. The full scale flow for the VLPC is 500 sccm. A coarse MFC (500 sccm) is used in parallel with a fine MFC (25 sccm) to achieve a wide range of flow with very fine control resolution. After controlling to a pressure near the target, the high flow MFC is set to a constant flow while the low flow, 25 sccm, MFC performs the fine control to achieve and maintain pressure within specifications.

3.4 RANGE RESTRICTIONS

Given a stable controlled flow, the pressure is defined as the drop across a given range restriction. The thermal and mechanical stability of the restrictions is critical to the stability and controllability of pressure.

The five lowest conductance (highest pressure range) restrictions are accomplished with a piston and block configuration very much like a 5 slm **DHI** molbloc. The highest conductance (lowest pressure range) restriction (labeled R1) is used in absolute mode only. R1 is accomplished by flowing through a short section of 16 mm ID tubing and a large vacuum valve in a manifold before attaching to KF-25 vacuum tube and a vacuum pump.

The following tables list the pressures available for ranges in gauge and absolute modes.

Table 2. Nominal VLPC Ranges, 15 kPa Unit

ABSOLUTE RANGES			
RANGE	LOWEST PRESSURE* [PA]	LOWEST CONTROLLABLE [PA]	RANGE MAXIMUM [PA]
R0	0.8	1	5
R1	0.8	3	150
R2	50	100	1 500
R3	75	280	5 000
R4	100	650	15 000

*Note: The lowest pressure for a given range occurs when the pressure is set to 0 in that range. The pressure is generated by the flow of lubricating gas from the upper chamber through the range restriction selected.

GAUGE RANGES			
RANGE	LOWEST PRESSURE* [PA]	LOWEST CONTROLLABLE [PA]	RANGE MAXIMUM [PA]
R2	0	0.1	15
R3	0	0.5	150
R4	0	4	1 500
R5	0	9	3 000
R6	0	50	15 000

*Note: The lowest pressure for each range in gauge mode is 0. The bypass valve is opened whenever the pressure is set to 0 in any gauge range. The conductance of the bypass in gauge mode is low enough that there is no measurable pressure difference due to the flow of lubricating gas from the upper chamber.

3.5 CONTROL

VLPC control is designed to set the pressure to the target value and control continuously to keep pressure within the hold limit and as close to the target value as possible. The advantage of this type of control scheme is that the final pressure achieved will be very close to the target value. However, control noise can lead to errors unless the FPG pressure (and DUT pressure if available) is averaged. For this reason FPG Tools contains an averaging feature for running tests and logging data (see Sections 6.4.2, 6.7.4).

The control of both the coarse (high flow) and fine (low flow) MFCs is accomplished with PID control based on pressure readings. The FPG pressure is used for all control readings all ranges for optimum control and resolution.

3.6 READY/NOT READY

Regardless of the current control state of the VLPC, any information logged in the system status will force a "Not Ready" condition (see the **<Status>** values in Section 6.3.7). Provided this is not the case, a "Ready" condition from a VLPC perspective is obtained while controlling when the FPG pressure is within the hold limit specified by the **<Hold Limit>** option in **<Settings>** (see Section 6.6.1). Figure 11 graphically portrays the ready criterion while the VLPC is controlling. When the VLPC is not controlling, the "Ready" condition is based on the **<Stability Setting>**.

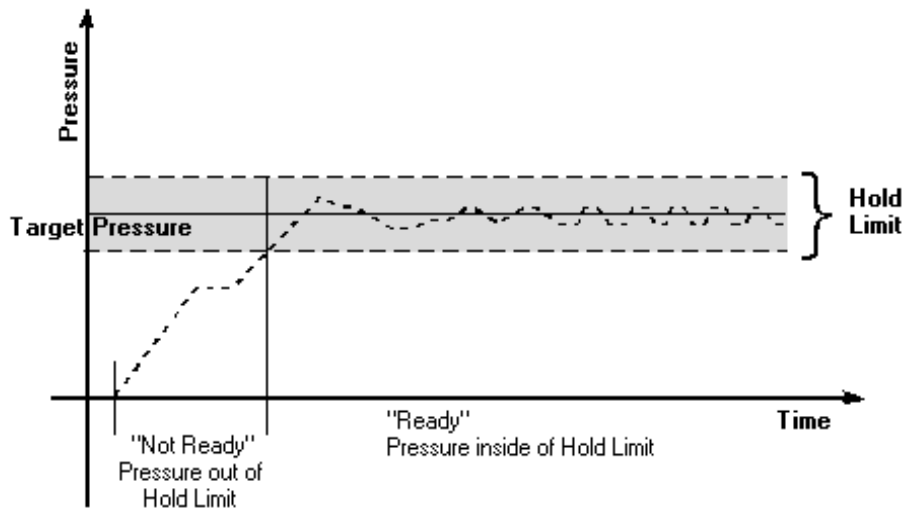

Figure 11. VLPC Ready Criterion

4. GETTING STARTED

4.1 OVERVIEW

The topics in this section describe the basic requirements of setting up FPG Tools PC software and the FPG/VLPC hardware. After the system is properly set up, these steps should be required for maintenance and troubleshooting purposes only.

Figure 12 is a complete FPG8601 calibration system schematic. Refer to this figure as needed when setting up the FPG and following procedures in this section. Figure 4 and Figure 5 describe the connections on back of the FPG and VLPC.

4.2 INSTALLING FPG TOOLS

Insert the installation CD included with the FPG8601 to install FPG Tools. When the CD is inserted it will automatically execute the FPG Tools installation program. However, if the auto run feature is disabled in Windows this will not occur. If this is the case, use the **[Windows Control Panel], [Add Remove Programs]** feature. To locate this option press the **[Start]** button on the main task bar, choose **[Settings]**, then select **<Control Panel>**. Choose the **[Add Remove Programs]** option and press the **<Install>** button. Follow the prompts of this dialog to install FPG Tools. A new program group with a shortcut to this manual and FPG Tools software will be added to the program menu of the host PC. To run FPG Tools, simply click the FPG Tools icon.

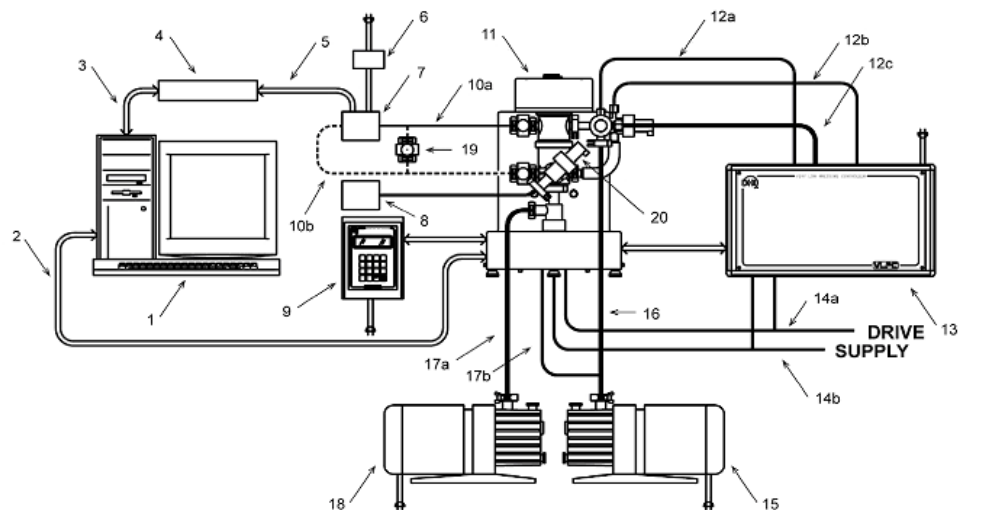

- | | |
|--|--|
| 1. PC with two RS232 ports | 12b. Control low connection |
| 2. PC to FPG8601 serial cable | 12c. Control vacuum connection |
| 3. PC to DUT data acquisition serial cable | 13. Very Low Pressure Controller (VLPC) |
| 4. DUT data acquisition (DMM, I/F box) | 14a. Drive air (valve actuation) |
| 5. Data acquisition to DUT connection | 14b. Pressure supply |
| 6. DUT Power Supply | 15. VLPC vacuum pump |
| 7. Device Under Test (DUT) | 16a. VLPC vacuum connection |
| 8. Capacitance Diaphragm Gauge to measure residual vacuum in absolute mode | 16b. FPG8601 lubrication vacuum connection |
| 9. FPG8601 local interface and power supplies | 17. FPG8601 reference vacuum connection |
| 10a. FPG8601 to DUT "high" side pressure connection | 18. FPG8601 reference vacuum pump |
| 10b. FPG8601 to DUT "low" side pressure connection | 19. DUT isolation valves |
| 11. FPG8601 | 20. Vacuum reference sensor isolation valve (Used in horizontal position only) |
| 12a. Control high connection | |

Figure 12. FPG8601 System Schematic

4.3 SETTING UP FPG TOOLS

Run FPG Tools by using the FPG Tools icon located in the program group created during the installation. Before any of the **[Run]** menu options are used to start the automatic update of the FPG pressure, the FPG calibration file and initial program configuration must be set up. After this information is correctly set up, future configuration changes are necessary only to change the existing setup. FPG Tools saves all setup information so that the last saved configuration is automatically available for each run of the program. Use the options in the **[Config]** menu to complete this setup.

Use **[Config], [System Setup], <Setup>** to specify the current local gravity, calibration gas, vacuum reference and the FPG RS232 interface settings. Enable the VLPC if it will be used to control pressure. Select **<Use vacuum reference for absolute mode correction>**. In some cases this information is pre-installed.

Use **[Config] [DUT Editor]** to set up any DUTs that will be used with the system. This is an optional task that can be skipped. DUTs can be setup at any time (see Sections 6.8, 6.6.2.3).

Use **[Config], [FPG Calibration Setup]** to enter all of the FPG specific calibration information (see Section 6.6.3). This is the most important step in the software setup process. Using default information in all other aspects of the program will not yield invalid pressure output data. However, an improperly configured FPG calibration file will always generate inaccurate data. This file is pre-configured for some FPG installations. If this is the case, verify that the values displayed match any documented values provided. If any changes are made, you must press "Accept" for changes to be saved.



Improper setup of the FPG calibration file will yield invalid pressure output data from FPG Tools.

When the above information is properly set up, there is no need to repeat these steps unless a new setup is required. Use the **[Run], [Run Monitor]** menu choice to begin polling the FPG after all hardware is properly set up.

4.4 BASIC FPG HARDWARE SETUP

This process explains critical steps that must be taken prior to using the FPG. The following steps cover setting the FPG on the calibrating surface, adjusting regulators for proper system pressures, and fine tuning the system.

Table 3. Equipment for Basic FPG Hardware Setup

EQUIPMENT
FPG
FPG piston
FPG cylinder
Bottled compressed gas (air or N ₂)
Regulator (from bottle pressure in / 700 kPa out)
Personal computer
RS232 cable
Various tube's and adaptors
2.5 mm Allen wrench
Distilled water
Shop air 700 kPa (100 psi)

- 1 Place the FPG on the site table with the mounting post facing the back of the table.



Take care not to cause any shock to the FPG by bumping or dropping the unit on the desk. The FPG contains extremely sensitive measuring components that must be replaced when damaged.

- 2 Place the FPG terminal on the table to the right of the FPG.
- 3 Add distilled water to the FPG bubbler system. (See Section 8.2).
- 4 Connect the FPG terminal to the FPG terminal port on the rear panel of the FPG using the supplied 25-pin cable.
- 5 Connect electrical power to the FPG terminal.
- 6 Connect an RS232 cable from COM1 of the FPG to an RS232 communications port on the PC.
- 7 Level the FPG using the two rear adjustable feet. Use the bubble level on the top of the FPG during the leveling process.
- 8 Connect the supply bottle to the inlet of the external regulator that will be adjusted to 700 kPa (100 psi). It is recommended to have at least 3.5 MPa (500 psi) in the bottle. This will ensure that the bottle pressure will always be greater than 700 kPa (100 psi).



Do not turn the pressure on the unit at this time. When the FPG is shipped, the piston and cylinder come detached from the unit. Pressurizing the unit prematurely could introduce contaminants into the system.

- 9 Attach the outlet of the external 700 kPa (100 psi) regulator, to the “lubrication pressure” port on the back of the FPG.

4.5 SETTING UP THE PISTON-CYLINDER

When the piston-cylinder is shipped, it comes in a hard plastic molded case to keep it firmly in place. A 2.5 mm counter sink screw is in the lower section of the bullet case. By removing this screw, atmospheric pressure is introduced into the piston-cylinder case. This will allow the piston-cylinder to be removed easily.

- ❶ Remove piston-cylinder bullet case from the shipping package.
- ❷ Remove the 2.5 mm screw on the lower (flat) section of the bullet case.
- ❸ Place the bullet case on a stable surface with the flat surface against the table.
- ❹ Grip the upper and lower portion, and gently twist the upper portion in a counter-clockwise position.
- ❺ Remove the upper section of the bullet case.
- ❻ Put on gloves to protect the piston-cylinder from contamination.
- ❼ Cup the exposed piston-cylinder assembly with one hand and turn the piston-cylinder and lower section of the bullet case upside down supporting the piston-cylinder with the cupped hand.
- ❽ Slide the lower section off of the piston-cylinder.
- ❾ Place the piston-cylinder on to a stable soft surface (lint-free towels).
- ❿ Re-attach the screw back in the lower section of the bullet case.
- ⓫ Mate the upper and lower section of the bullet case.
- ⓬ Clean and assemble the piston-cylinder then insert it into the mounting post. These steps are described in Section 7.

4.6 CONNECTING THE FPG MANIFOLD AND VALVES

The bypass/control manifold is connected to the right side of the FPG8601. This part is essential for automated operation of the system. Follow the steps below and refer to Figure 13 for information on connecting the manifold.

- ❶ Make sure the lower mounting post is properly secured on the FPG (see Section 7.6). The PRT and pressure connections should be made prior to continuing.
- ❷ Connect the FPG manifold to the mounting post. Use Figure 13 for proper orientation.

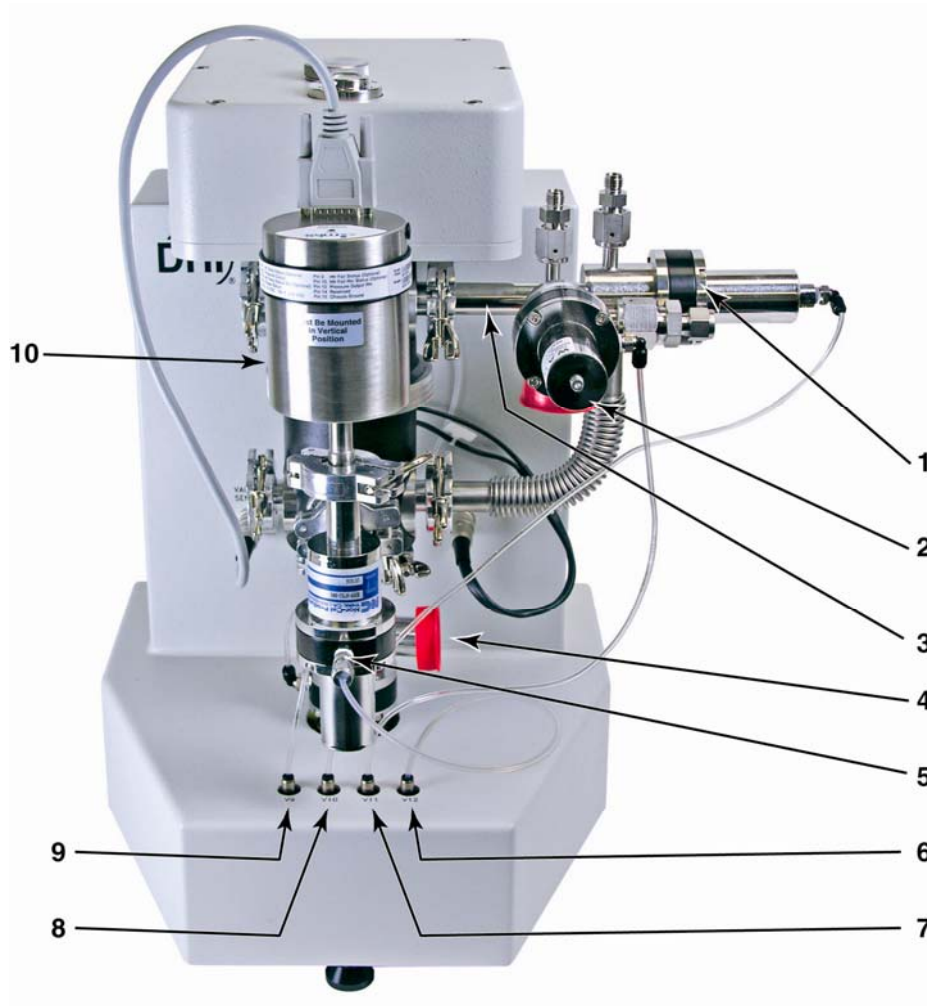

- | | |
|--|-----------------------------|
| 1. Bypass Valve (10) | 6. Valve Driver (12) |
| 2. Vacuum Control Reference Valve (11) | 7. Valve Driver (11) |
| 3. FPG8601 Manifold | 8. Valve Driver (10) |
| 4. Vacuum Valve (9) | 9. Valve Driver (9) |
| 5. Vacuum Reference Isolation Valve | 10. Vacuum Reference Sensor |

Figure 13. FPG8601 Manifold Connection

- ③ Connect the normally closed pneumatic valve to the bottom of the lower mounting post.
- ④ Connect a piece of the supplied flexible tubing to the drive port of each valve.
- ⑤ Connect valve driver 9 to the vacuum reference valve with the supplied tubing.
- ⑥ Connect valve driver 10 to the bypass valve with the supplied tubing.
- ⑦ Connect valve driver 11 to the vacuum control reference valve with the supplied tubing.
- ⑧ Connect the open end of the reference vacuum sensor valve to the front of the mounting post. Make sure the vacuum reference sensor is in the vertical position.



Always mount the vacuum reference sensor in the orientation used for zeroing. A significant zero-shift can occur when the sensor is not mounted in the orientation in which it was zeroed (see Section 8.3). It is recommended that the sensor be zeroed in the vertical orientation. When zeroed horizontally, the rotation of the sensor also affects the zero. This makes it difficult to mount remove and remount sensor without affecting the zero.



Make sure the electrical connector of the sensor is also connected to the port on the upper left of the FPG base.

- 9 Connect valve driver 12 to the valve attached to the vacuum sensor with the supplied tubing.

4.7 SETTING UP THE FPG FOR OPERATION

The FPG can be set up to use both gauge and absolute pressure measurement modes on demand. If the following steps are performed, simply using the **[Units]**, **[Gauge Mode]** (or **[Absolute Mode]**) option is all that is required to change the current pressure measurement mode (see Section 6.9.2). Since the initial power up condition of the FPG is gauge measurement mode, the majority of the steps in this procedure are related to setting up absolute measurement mode.

- 1 Connect the FPG manifold to the mounting post (see Section 4.6).
- 2 Attach the KF25 pneumatic valve to the bottom of the FPG lower mounting post (this may already be attached). Connect the actuation line of the valve to driver 9 (V9) on the far left of the FPG base.



If you are only going to use the FPG in gauge mode only you do not have to continue with the following steps in this procedure. Absolute mode requires two vacuum pumps for reference pressure and control pressure.

- 3 Attach a KF25 tee to the D16b vacuum pump's inlet port.
- 4 Attach a 1 000 mm KF25 bellows tube to the vertical port on the KF25 tee.
- 5 Attach the opposite end of the KF25 bellows tube to V11 on the FPG manifold.
- 6 Attach the KF25 x 1/4 in. Swagelok adaptor to the remaining port on the KF25 tee.
- 7 Install the vacuum bleed kit assembly on the 1/4 in. Swagelok fitting.
- 8 Route a 1/4 in. PFA tube from the 1/4 in. Swagelok fitting on the other end of the bleed kit assembly to the VACUUM port on the back of the FPG.
- 9 Install the KF25 by KF40 vacuum elbow connecting to the KF25 fitting on valve 9 on the FPG mounting post and routing it through the hole in the bench. Connect the elbow to the bench using the holding collar and brackets.
- 10 Attach the turbo pump to the vacuum tube that extends down through the bench using a KF40 flange and a the KF40 centering ring with a screen. Orient the pump so that its lateral KF16 port is facing towards left (as viewed from the front of the bench).
- 11 Attach turbo pump controller cable (on turbo pump controller) to the turbo pump.
- 12 Install PFA vent bleed tube between the adaptor and the bulkhead on the rear of the turbopump controller.
- 13 Install a KF16 x KF25 adaptor onto the turbo pump KF16 lateral port.. Attach a KF25 plastic hose from the adaptor to the roughing vacuum pump.

4.8 SETTING UP THE VLPC

The following procedure will connect the VLPC to the FPG. The VLPC and the FPG will use the same bottle and downstream regulator for the supply pressure. When placing the VLPC next to the FPG, ensure that the provided PFA tubes will reach the appropriate parts. If the tubes do not reach, move the VLPC closer to the FPG. It is assumed that the FPG piston has already been inserted into the mounting post at this point. Refer to Section 4.4 for VLPC connections.

- ❶ Place the VLPC on the right side of the FPG approximately six inches away.
- ❷ Attach the Test (Lo) port from the VLPC to the Control Low port on the FPG manifold. Use the 1/4 in. PFA tubing with the VCO connection on one end. Before connecting the VCO connection, ensure that the O-rings are attached to the Test (Lo) port on the back of the VLPC.
- ❸ Attach the Test (Hi) port from the VLPC to Control High port on the FPG manifold. Use the 1/4 in. PFA tubing with the VCO connection on one end. Before connecting the VCO connection, ensure that the O-rings are attached to the Test (Hi) port on the back of the VLPC.
- ❹ Attach the FPG Vacuum port from the VLPC to Vacuum port on the FPG manifold. Use the 3/8 in. PFA tubing with the VCO connection on one end. Before connecting the VCO connection, ensure that the O-rings are attached to the FPG Vacuum port on the back of the VLPC.
- ❺ Attach the 700 kPa (100 psi) regulated pressure to the “Supply” port on the back of the VLPC. Do this by using 1/4 in. PFA tubing that has been teed off from the output of the regulator downstream from the bottle.
- ❻ Attach drive air to the external port labeled “Drive Pressure” on the rear panel of the VLPC. The drive pressure should be between 620 to 760 kPa (90 to 110 psi).

4.9 INTRODUCING GAS TO THE FPG

When the FPG is vented or the bottle has been turned off, the lubrication pressure must be reintroduced. The steps below describe the proper sequence for a safe introduction of gas to the FPG. If not done properly, a reverse pressure situation can be created that can contaminate the system.

- ❶ Introduce drive air to the VLPC and FPG.
- ❷ Make sure that the 700 kPa (100 psi) regulator is shut off before turning the bottle pressure on.
- ❸ Turn on the bottle pressure.
- ❹ Adjust the regulator to 700 kPa (100 psi). The gas will flow through the water in the bubbler.



The noise caused by the gas flow through the bubbler is normal. The lubrication gas flowing into the lubricating volume and the surrounding piston creates the bubbles. By forcing the gas through the bubbler, the FPG is capable of controlling the humidity of the gas regardless of the humidity of the source gas.

- ❺ The gas will fill the lubricating volume to approximately 40 kPa (5.8 psi) above atmosphere.
- ❻ Start FPG Tools software (if not already active) and choose **[Run]**, **[Run Monitor]**.
- ❼ Verify that the FPG is level. Use the bubble level on the top of the FPG and make adjustments with the rear feet as necessary.

4.10 CONNECTING A DUT

The three measurement modes that the FPG can measure are gauge, absolute, and absolute differential. Each of the measurement mode setups are described in the following sections. Realize that the FPG can be set up to run all modes by following the measurement mode setup procedure (see Section 6.9.2). If this procedure is followed, only a few toolbar and/or menu options are required to change to any mode of operation. See Section 4.11 for details on how to set up a DUT that will be used in the FPG manifold.

4.10.1 GAUGE MODE

This procedure will allow the calibration of gauge DUTs using the FPG as a primary standard and the VLPC as the pressure controller.

- 1 Attach the Test(+) side of the DUT to the upper left KF16 port, Test (Hi).
- 2 If available, attach the Test(-) side of the DUT to the lower left KF16 port, Test (Lo). This is very important in gauge mode. Subtle changes in ATM will cause erroneous data if the ports aren't connected together.



If a reference port is available on the DUT attach the connection to the test low port of the FPG. Doing so will ensure that both the FPG and the DUT will see any changes in ambient pressure.



It is recommended that a valve be placed, joining the Test(+) and Test(-) ports of differential DUTs together. This valve will be used to short the DUT's ports together to achieve an accurate determination of zero.

4.10.2 ABSOLUTE MODE

This procedure describes how to connect an absolute DUT to the FPG and use the VLPC as the pressure controller. It is assumed that the FPG and the VLPC have been set up according to the gauge/absolute setup procedure (see Section 6.9.2) and that the FPG is currently running in gauge mode.

- 1 Turn the power off of the FPG.



If the vacuum reference sensor is already attached to the FPG there is no need to power down the FPG. It is best to always leave the vacuum reference electrically connected even when it is not used. This avoids the delay associated with the warm up time of the sensor.

- 2 Attach the vacuum reference sensor to the FPG (see Section 4.6).
- 3 Attach KF16 shut-off valves to the test and reference ports of the FPG.



Adding these valves will allow for changing DUTs while keeping the FPG in absolute mode.

- 4 Connect the test port of the DUT to the KF16 valve that is attached to the test high port of the FPG.



If the DUT requires adaptations that require tubing, use the shortest tube length possible with an inside diameter of at least 15 mm. If only smaller inside diameter tubing is available, the test will require longer waiting periods prior to taking a point.

- 5 Select **<Use vacuum reference sensor for absolute mode correction>** under the **[Config], [System Setup]** menu on the FPG Tools software. (See Section 6.6.2.1.)
- 6 Turn on both vacuum pumps.
- 7 Change the FPG to absolute mode by selecting **[Units], [Absolute Mode]** from the main menu in FPG Tools (see Section 6.9.2.2).

4.10.3 ABSOLUTE DIFFERENTIAL MODE

This procedure describes the setup of an absolute differential DUT using the FPG as a primary standard and the VLPC as the pressure control device. To begin, the FPG and the VLPC must be set up according to the gauge/absolute setup procedure (see Section 4.6) and the FPG is currently running in gauge mode.



If you want to be able to measure the reference pressure on the FPG for monitoring purposes or for thermal transpiration correction, the vacuum reference sensor should be attached prior to going to absolute mode. Using the vacuum sensor in this mode is optional. If there is no need to monitor the reference pressure, ignore steps related to the vacuum reference sensor.



If the vacuum reference sensor is already attached to the FPG there is no need to power down the FPG.

- 1 Turn the power off of the FPG.
- 2 Attach the vacuum reference sensor and isolation valve onto the front of the FPG. Make sure the sensor is vertical..
- 3 Power on the FPG.
- 4 Observe the warm up time that is required for the reference vacuum sensor (if necessary).
- 5 Determine what type of fitting(s) will be required to adapt from the Test (Hi) port of the DUT to the KF16 upper left Test (Hi) port on the FPG.
- 6 Determine what type of fitting(s) will be required to adapt from the Test (Lo) port of the DUT to the KF16 tee that is attached to the lower left Test (Lo) port of the FPG.



It is recommended that shut-off valves be placed on the high and low ports of the FPG (see Figure 12). Adding these shut-off valves will allow a DUT to be changed while keeping the FPG in absolute mode. In addition, by adding these valves it will be possible to keep the DUT evacuated of gas while other FPG processes are taking place (zeroing, purging, etc.).

- 7 Attach the DUT Test (Hi) port to the upper left port on the FPG, Test (Hi).
- 8 Attach the DUT Test (Lo) port to the lower left port on the FPG, Test (Lo).



It might be necessary to use tubing in order to attach the DUT to the FPG. If needed, KF16 bellows tubing is recommended. Tubing of comparable volume and flexibility can be used.

-
- ⑨ Power on the DUT.



Most DUTs require a warm-up time before they can be calibrated accurately. Check the DUT users manual for the proper warm-up time.

-
- ⑩ Using two tubes and a shut-off valve, connect the DUT's test and reference ports together.



For safety reason, shorting the test port to the reference port will ensure that the differential pressure across the DUT will remain near zero in all conditions. When the test begins, the DUT's test and reference ports should be isolated using the shut-off valve between the two ports.

-
- ⑪ Open the shut-off valve between the high and low port of the DUT.
 - ⑫ Turn on both vacuum pumps.
 - ⑬ Switch the FPG to absolute mode (see Section 6.9.2.2).

4.11 CONNECTING THE DUT MANIFOLD

This section describes how to setup the optional DUT manifold. If properly setup, the manifold can be used in gauge, absolute and absolute differential mode with up to 3 DUTs without having to adjust plumbing. The manifold must be turned on in FPG Tools by using tools on the **[Config]**, **[System Setup]**, **<Options>** tab (see Section 6.6.2.2).

The steps below describe what is required to setup the DUT manifold.

- ① Set the manifold on the table so that the two pneumatic valves are closest the left side of the FPG test ports.
- ② Attach a KF16 15 in. bellows tube to the Test (hi) port on the FPG.
- ③ Attach a KF16 15 in. bellows tube to the Test (low) port on the FPG.
- ④ Attach the remaining ends of the bellows tubes to the DUT manifold's hi and low ports.
- ⑤ The two bellows tubes should be parallel to each other.
- ⑥ Fasten the external valve driver cable to the connector labeled "external drivers" on the back of the FPG.
- ⑦ Attach the remaining end of the external valve driver cable to the associated connector on the DUT manifold.
- ⑧ Attach shop air (regulated to 700 kPa (100 psi)) to the 1/8 in. NPTF fitting on the manifold.
- ⑨ DUTs should be connected to the manifold by adapting as necessary. When possible connect differential and gauge DUTs to both the high and low ports of the manifold. This ensures that the DUTs and the FPG are using the same reference pressure.

4.11.1 SETTING UP THE TURBO PUMP

The turbo pump attached to the manifold will be used in two different situations. First, the turbo pump will evacuate the entire manifold in order to zero DUTs (see Section 5.6). Secondly, the turbo pump will be continuously maintaining a vacuum on the reference side of the manifold when in absolute mode and the vacuum pump is active. In absolute differential mode, the vacuum pump is not used (see Section 5.4). FPG Tools only supports the Varian 150 Dry Var turbo molecular pump, model 9699163.

- ❶ Place the turbo pump on the bracket beneath the DUT manifold.
- ❷ Place the ISO-63 sealing clamp on top of the turbo pump.
- ❸ Place the ISO-63 X 8VCR bellows tubing upon the ISO-63 sealing gasket.
- ❹ Fasten down the ISO-63 section with the associated ISO-63 clamps.
- ❺ Adjust the turbo pump platform to the appropriate height.
- ❻ Place an 8VCR metal gasket between the bellows tube and valve 13 on the DUT manifold.
- ❼ Tighten the 8VCR nut onto valve 13 by rotating the 8VCR nut clockwise 1/16 of a turn from finger tight.
- ❽ Readjust the turbo pump platform if necessary.
- ❾ Attach the remote communication cable to the “J4 serial” connector on the turbo pump.
- ❿ Attach the RS232 9-pin connector to a COM port on the back of the PC. This port must be specified to activate the pump.
- ⓫ Attach the restriction and vent valve to the vent “nut” on the turbo pump.
- ⓬ Connect the power cable connector for the vent valve to the P1 vent connection on the turbo pump.
- ⓭ Turn the pump on. The power light should turn on but the pump should not start spinning. If the pump does begin spinning, the remote communications cable must not be connected properly.
- ⓮ Use the **[Config]**, **[System Setup]**, <**Options**> tab (see Section 6.6.2.2) to activate the pump and to specify the RS232 COM port.
- ⓯ FPG Tools will automatically use the pump as needed. However, the pump can be manually controlled by using the tools on the <**DUT Manifold**> display (see Section 6.3.8). The current speed and current of the vacuum pump will display on this form.

4.11.2 CONNECTING THE ION GAUGE

The ION gauge will be used for determining how low the DUT manifold has been pumped down to when zeroing the manifold (see Section 5.6). The output of the ion gauge can help to determine if the DUT has been pulled down low enough for zeroing. The Granville-Phillips Series 360 ion gauge system is the only supported ion gauge that can be used with FPG Tools.

- ❶ Attach the DB25 cable from power source to the DB25 connector on the back of the signal conditioner.
- ❷ Attach the circular connector cable to the back of the power supply.
- ❸ Attach the coaxial connector to the signal conditioner.
- ❹ Attach the DB25 X DB9 adapter to the RS232 DB25 connector on the back of the signal conditioner.
- ❺ Attach a 9-pin RS232 cable to the adapter to a COM port on the PC.
- ❻ Attach the ION gauge cable to the ION gauge.
- ❼ Note that there is only one orientation that the connector will fit.

- ⑧ After connecting the ION gauge cable, lock in the protective housing by rotating it clockwise 1/4 turn.
- ⑨ Use the **[Config]**, **[System Setup]**, **<Options>** tab (see Section 6.6.2.2) to activate the ion gauge and to specify the RS232 COM port.
- ⑩ FPG Tools will automatically use the ion gauge when zeroing the DUT manifold. Refer to the **<DUT Manifold>** display (see Section 6.3.8) to control the ion gauge and to view the current pressure output.

4.12 CHANGING LUBRICATION GAS

To change lubrication gas, the FPG must be shut down (see Section 5.9). All of the basic supply connections to the FPG must then be set up with the new gas (see Section 4.4).

- ① Press the **[Shut Down]** icon on the FPG Tools software. Wait until FPG Tools displays **<SHUTDOWN>**.
- ② Turn off the regulator that connects the FPG to the supply bottle.
- ③ Turn off the supply bottle.
- ④ Crack the fitting on the supply port of the FPG. Slowly bleed the supply pressure from the supply port of the FPG by loosening the Swagelok fitting.
- ⑤ Once the supply fitting is removed, slowly turn the regulator up to release any pressure trapped between the regulator and the bottle.
- ⑥ Remove line from the bottle.
- ⑦ Change the bottle to the new gas.
- ⑧ Reattach the supply fitting onto the supply port of the FPG.
- ⑨ Make sure that the regulator is turned down (off).
- ⑩ Turn on the bottle.
- ⑪ Adjust the supply regulator to 700 kPa (100 psi).
- ⑫ Press the shut down icon on the FPG Tools software to reset gauge mode operation.
- ⑬ Use the **[Config]**, **[System Setup]** menu option and locate the **<Lubrication Gas>** option found on the **<Setup>** folder. Select the new gas then press **<Accept>** to store the change.

4.12.1 PURGING THE LUBRICATING VOLUME WITH A NEW GAS

When lubricating gas species a process of purging must take place. If the purging sequence is not performed, there will be multiple mixing gases in the lubricating volume. This will cause the determination of air density to be incorrect as well as affect the zero stability of the load cell. Refer to Section 11.1 for a complete valve schematic of the FPG.

- ① The FPG should be in gauge mode.
- ② Change the user level mode to factory mode if FPG Tools is not already in factory mode (see Section 6.10).
- ③ Activate valve six on the valve toolbar.
- ④ Allow valve six to be active for approximately 15 minutes.
- ⑤ Deactivate valve six on the valve toolbar.
- ⑥ Press the purge toolbar button in order to reach a stable humidity.

4.12.2 PURGING THE TEST PORT

The test port of the FPG must be purged when using any gas other than compressed air. When a DUT is changed, ambient air is trapped in the DUT and the test port of the FPG. This creates a mix of gas in the test port of the FPG, therefore this procedure should be performed every time a new DUT is used and compressed air is not the FPG lubricating gas. The following procedure will purge any air that is trapped in the test port, and introduce the new supply gas.

- ❶ Set a pressure to full scale of the DUT using the **<VLPC Interface>** window (see Section 6.3.6).
- ❷ Vent the test pressure using the **[Vent]** option on the **<VLPC Interface>** window. The pressure does not have to be stable for any particular amount of time.
- ❸ Cycle the two previous steps at least five times.
- ❹ Alternatively, see Section 6.7.6 for cycling pressure in a test sequence.

NOTES

5. SYSTEM OPERATION

5.1 OVERVIEW

This section describes general operation of the FPG after the system is properly set up. This includes: all necessary pneumatic supply connections to the VLPC and FPG, control connections between the FPG and VLPC, the connection of any DUT that may be used with the system, all instruments are powered on and FPG Tools is in **[Run Monitor]** run mode (see Section 6.5.2). Refer to Sections 7, 8 and 10 for information on maintenance and troubleshooting the FPG.



Always start FPG Tools with the [Run], [Run Monitor] menu option (see Section 6.5.2). This puts the software in a mode that is very similar to a standalone instrument. The outputs of the FPG and any connected DUT are automatically polled by the software and all toolbar functions are active. From this state all basic operations of the FPG can be performed.

5.2 ZEROING THE FPG

The FPG should be zeroed frequently to avoid errors associated with changes in conditions and zero drift. More specifically, always zero the FPG when: first powered on, after changing measurement mode and warming up (see Section 6.9.2), before making a comparison with another instrument and when tare conditions have changed beyond the factory limits (see Section 6.6.4). Because of the importance of this function, a pneumatic bypass valve is built into the FPG to allow fully automated zeroing. To zero the FPG, press the **[Zero System]** toolbar option (see Section 6.6.4). FPG Tools will first set a zero condition in the FPG, wait for stability, then activate the new zero data. The active zero results are available on the **<Tare Values>** display window (see Section 6.3.3).

5.2.1 ZERO CONDITION

In gauge mode, the zero condition is reached when the bypass valve is open and all pressure control connections to other instruments are isolated. Basically, the FPG should have the high and low ports directly connected together with no other pressure influences. FPG Tools automatically makes the valve adjustments as necessary when possible and vents any controlled pressure in the VLPC.

The absolute mode zero condition is the same as the gauge condition with the addition of deactivating the reference port vacuum isolation valve (V9). The reference port vacuum must be isolated to prevent a bias associated with the natural differential pressure caused by flow from the upper port through the bypass to the vacuum. The pump does not have to be turned off while zeroing.



While zeroing the FPG in absolute mode, the FPG line pressure will increase due to the lubricating flow. If left in this state for a prolonged amount of time, the FPG line pressure will exceed the lubrication pressure causing a reverse pressure situation. Using the automatic zeroing function of FPG Tools will avoid this by imposing a timeout on the zero process. If proper zero conditions are not met, the zero process is aborted and an error message is displayed on the status bar.

5.2.2 STABILITY TEST

After the zero condition is set, the stability test must be passed prior to logging zero information for the system. The stability test first waits a fixed 15s in gauge mode or 25s in absolute mode to allow any transient pressure effects to pass. Then the load cell output, N, must be stable within the specified **<Load cell stability criterion for zeroing...>** setting on the **<Mass>** tab of the **[Internal Limits]** (see Section 6.6.4.5) for three consecutive readings. In addition, lubrication pressure must be stable within the specified **<RPT stability criterion>** on the **<Pressure>** tab of the **[Internal Limits]** (see Section 6.6.4.2).

5.2.3 STORE ZERO DATA

The final step in zeroing the system is to store the current zero information. The load cell output, ATM, temperature and lubrication pressure at the end of the stability test are automatically stored and activated. All new tare information displays on the **<Tare Values>** window (see Section 6.3.3). FPG Tools also logs zero information into the "syszero.log" file (see Section 9.4). The information logged in this file can be used to determine zero drift for automated tests.

5.3 INTERNAL CALIBRATION

The internal calibration performs a single point span adjustment on the FPG (see Section 2.3). Using this function in combination with the **[Zero System]** option is what is required to obtain the best accuracy for the FPG. Press the **[Internal Calibration]** toolbar option to initiate an internal calibration (see Section 6.4.2).



*For best results, use the **[Config]**, **[System Setup]**, **<Run internal calibration after each system zero>** option to couple zeroing and internal calibrations (see Section 6.6.2.1).*



An internal calibration must be run prior to taking data after changing measurement modes. The change in lubrication pressure around the load cell can cause a span shift that must be taken into account.

The internal calibration is performed in the active conditions of the FPG. This could mean that the FPG is in a zero condition or at a stable controlled pressure. In either case, the stability criterion must be met before proceeding (see Section 5.2.2). When stable conditions are obtained, FPG Tools determines the calibration mass value then calculates a new calibration factor and provides options to activate, log or ignore the calibration. Since the calibration is not automatically activated, this feature can be used as a calibration check.

5.3.1 DETERMINING CALIBRATION MASS VALUE

The measured internal calibration mass value is obtained by raising and lowering the internal calibration mass several times and taking an average. This averaged mass value is used for calibration factor calculations (see Section 11.3.5.4). The steps below detail the automated FPG Tools process.

- ❶ Average the current load cell output (calibration tare). The calibration tare makes it possible to perform the internal calibration at a pressure. As a result, the load cell span can be checked at a different point in its range provided a stable pressure is available.
- ❷ Lower the internal calibration mass and again wait for stability.
- ❸ Average the load cell output subtracting the calibration tare obtained from Step ❶. The result is the internal calibration mass.

- 4 Raise the internal calibration mass and wait for stability.
- 5 Average the load cell output again to make sure that the original calibration tare is valid and the system has not drifted.
- 6 If the difference between calibration tares obtained before and after the mass load is lowered exceeds the **[Internal Limits] limit** specified by the **<Maximum deviation between calibration mass indications>** option (see Section 6.6.4.5), a warning message will display prior to activating calibration information.



If Run Test Sequence is active and the test is fully automated, a failure of this criterion forces FPG Tools to automatically log the results of the calibration, but not activate any new calibration data.

- 7 The above steps are repeated for the specified number of times to lower the internal calibration mass. This value is set using the **[Internal Limits] <Number of times to lower the calibration mass....>** option (see Section 6.6.4.5).
- 8 The individual calibration mass values obtained in the previous steps are averaged together to get a final calibration mass value.

5.3.2 ACTIVATING NEW CALIBRATION

The averaged calibration mass is used to determine a new calibration factor according to the equations detailed in Section 11.3.5.4. The results display on the **<Internal Calibration Results>** form. Use the information on this window to determine whether or not to activate, log or ignore the results of the internal calibration.



Always log the results of the internal calibration unless an obvious error occurred during the calibration process. The information logged in the "intcal.log" file (see Section 9.3) can be very useful for troubleshooting.

When all calculations are complete, the **<Internal Calibration Results>** window displays. If any limits were exceeded or errors occurred during the calibration process, an error message will display at this time indicating the failure. This window contains all relevant calibration information required to determine whether or not to keep the new calibration. Select the desired option to complete the internal calibration process.

Internal Calibration Results		October 24, 2000 10:30:54
Conditions		
Temperature (°C)	21.20	<input type="button" value="Log Only"/> <input type="button" value="Activate New Calibration"/> <input type="button" value="Print"/> <input type="button" value="Cancel"/>
Pressure (kPa)	137.882	
N2 density	1.544052	
Calibration Mass Density	7900	
Local Gravity	9.79474	
Mass		
Averaged mass value (g)	776.767	
True Mass (g)	776.802	
Calculated True Mass (g)	776.805	
True Mass Difference (g)	0.003	
Calibration Factor		
Original K_Cal	9.793303e-6	
Calculated K_Cal	9.793262e-6	
Difference (PPM)	-4.3	

Figure 14. Internal Calibration Results Window

Table 4. Internal Calibration Results Options

LABEL	DESCRIPTION
Temperature (°C)	The mounting post temperature used to determine the density of the lubrication gas for the air buoyancy correction.
Pressure (kPa)	The pressure of the lubrication gas at the time of the internal calibration.
N2 (Air) density	The calculated density of the lubrication gas based on the pressure and temperature.
Calibration Mass Density	The active calibration mass density setup in the [FPG Calibration Setup] (see Section 6.6.3).
Local Gravity	The local gravity specified by the [System Setup] <Local Gravity> option (see Section 6.6.2.1).
Averaged Mass Value (g)	The average internal mass value determined during the internal calibration process (see Section 5.3.1).
True Mass (g)	The true mass value of the internal calibration mass specified by the active [FPG Calibration Setup] (see Section 6.6.3).
Calculated True Mass (g)	After applying the air buoyancy correction to the <Averaged Mass Value> this true mass value is obtained. If everything is working perfectly, this value should be the same as the <True Mass> value.
True Mass Difference (g)	The difference between the calculated and actual <True Mass> values. This is an indication of direct mass error of the load cell when a load equal to the calibration mass is applied.
Original K_Cal	The active calibration factor determined from the last internal calibration or entered in the [FPG Calibration Setup] .
Calculated K_Cal	The calibration factor determined by the <Calculated True Mass> value. If the calibration is activated, this will become the new calibration factor.
Difference (PPM)	<p>The relative error between the current and calculated calibration factors. This value should always be less than the [Internal Limits], <Maximum deviation in calibration factor (PPM)> value (see Section 6.6.4.5).</p> <hr/> <p> <i>When running repeated internal calibrations in the same measurement mode, this value is typically on the order of 5 PPM or less. Changes significantly larger than this may be the result of an unstable <Averaged Mass> value. When measurement modes are changed, the calibration factor can change by 20 PPM or more.</i></p> <hr/>
Log Only	Press this button to log the results of the calibration in the "intcal.log" file without activating the new calibration factor (see Section 9.3).
Activate New Calibration	Press this button to log the results of the calibration in the "intcal.log" file and activate the new calibration factor. The value displayed as the <Calculated K_Cal> will become the active calibration factor.
Print	Press this button to print a copy of the <Internal Calibration Results> window to the default windows printer.
Cancel	Press cancel to close the <Internal Calibration Results> window and ignore the results of the calibration. No information related to the calibration is saved.

5.4 SETTING A MEASUREMENT MODE

When the steps in Section 4.6 are followed, the FPG can be switched between gauge and absolute measurement modes by simply using the corresponding **[Units]**, **[Absolute Mode]** or **[Gauge Mode]** menu option. To set absolute differential mode, just follow the same steps required to set absolute mode, but select the **[Config]**, **[System Setup]**, **<Use vacuum reference for data logging only>** option (see Section 6.6.2.1). This prevents the conversion of the FPG differential pressure into an absolute pressure. In absolute mode, this setting must be **<Use vacuum reference for absolute mode correction>**. Refer to Section 6.9.2 for details on how FPG Tools changes measurement modes.

When the optional DUT manifold is activated, changing measurement modes in the FPG automatically changes the measurement mode in the DUT manifold. Make sure the manifold and manifold vacuum pump (if necessary) are activated in the system setup prior to changing measurement modes. While setting a measurement mode, the manifold is exposed to the FPG with the bypass valve open. After the transition is complete, the valves and manifold vacuum pump are adjusted to the state required by the measurement mode. When setting absolute mode the manifold vacuum pump is turned on and the lower manifold port is isolated from the FPG. In both gauge and absolute differential measurement modes, the manifold vacuum pump is turned off and vented and the upper and lower manifold ports are exposed to the FPG. Refer to the **<DUT Manifold>** display (see Section 6.3.8) to view the current state of the valves and the effect on the pressure in the manifold.



Only expose the DUT manifold to the FPG when the manifold bypass valve is open and both the manifold and FPG are in the same state. Failure to do so may overpressure DUTs connected to the manifold and/or damage the manifold vacuum pump.



Whenever a measurement mode is changed or reset, the VLPC is set to its minimum pressure range for the selected measurement mode.

5.5 USING A DUT WITH FPG TOOLS

FPG Tools provides features that support automated data acquisition from most DUTs that have an RS232 or IEEE-488 output. Manual DUTs are also supported by allowing their output to be manually entered into the software. Although manual DUTs are not automated, the manual DUT features provide a consistent data file structure that simplifies reporting of data. Follow the steps below to set up and use a DUT with FPG Tools. Refer to Section 4.10 for pneumatic connections related to using a DUT in a specific measurement mode.

- ❶ Set up the DUT using the **[Config]**, **[DUT Editor]** tab (see Section 6.8). Press the **[New]** toolbar option to create a new DUT or use the **[Copy]** button to begin with a duplicate copy of the DUT. Enter the necessary DUT information on each of the editor tabs then press the **[Save]** button.
- ❷ Select **[Config]**, **[DUT Selection]** and select the DUT(s) that will be used. Enter the serial number and identification of DUTs that are setup as profiles (see Section 6.6.5). If the DUT is RS232, click the displayed RS232 settings to change the COM port as needed. Press the **[Activate DUT(s)]** button to initialize and poll the output of remote DUTs. Press the **[Deactivate DUT(s)]** button to stop polling the DUTs.
- ❸ DUTs can be changed or edited at any time. However, changes to a DUT using the **<DUT Editor>** are not automatically activated to the DUT when it is already being polled by FPG Tools. Use **[Config]**, **[DUT Selection]** to re-activate the DUT with the changes. It is not recommended that DUTs be modified during tests. Any new DUT settings created after the test has begun are not logged into the data file.

5.6 ZEROING THE DUT MANIFOLD

To zero the DUT manifold, the turbo pump and manifold must be activated in the system setup (see Section 6.6.2.2). If the ion gauge is also activated, FPG Tools will automatically activate and degas the ion gauge when the pressure is low enough. When the ion gauge is not used, FPG Tools only isolates the manifold from the FPG, activates the manifold vacuum pump and waits for further input.

To begin, use the **<Window Display>** toolbar to display the **<DUT Manifold>** window and press the **[Zero DUT Manifold]** button. FPG Tools will automatically isolate the manifold from the FPG, open the manifold bypass valve and start the manifold vacuum pump. After the vacuum pump rotation speed reaches the limit specified in **[Config], [Internal Limits], [Pressure]** (see Section 6.6.4.2), the ion gauge will be turned on. The ion gauge degas option is turned on after it's pressure is below the limit required to activate the degas sequence. This limit is also specified in **[Config], [Internal Limits], [Pressure]**. The ion gauge automatically turns off degassing when it is complete. At this point, the ION gauge ready indicator will change to green to signify the completion of degassing. The entire process typically takes 2 to 3.5 hours depending on the volume associated with the manifold and the desired vacuum pressure. The manifold will remain isolated from the FPG with the vacuum pump on until the **[Operation Abort]** toolbar option is selected (see Section 6.4.2). When the zero process is aborted, the manifold will remain isolated from the FPG unless the FPG is also in absolute mode. If this is the case, a message displays to allow the manifold to remain isolated or to be exposed to the FPG. The manifold is not automatically exposed to the FPG after aborting.



Only expose the DUT manifold to the FPG when the manifold bypass valve is open and both the manifold and FPG are in vacuum conditions. Failure to do so may overpressure DUTs connected to the manifold and/or damage the manifold vacuum pump.

Because of the ion gauge ready indicator, the manifold zeroing can be run unattended for several hours. When the indicator is green, the ion gauge degassing is complete. At this point, the pressure in the manifold should be in a range acceptable to zero any DUTs connected to the manifold. Regardless, the manifold can be left in this state for as long as desired. Use the **<DUT Manifold>** display toolbar to control the ion gauge and vacuum pump as needed.

5.7 CHANGING PRESSURE WITH THE VLPC

To use the VLPC make sure the **[Config], [System Setup] [Setup], <Enable VLPC>** feature is checked (see Section 6.6.2.1). When active, the **<VLPC Interface>** window is enabled for use (see Section 6.3.6). The features of this control window allow pressure to be set, the range to be changed, control to be aborted and the active pressure to be vented. After a VLPC range has been selected, simply type in the desired target pressure and press **[Go]**. Use the **[Config], [System Settings] <Hold Limit>** and **<Stability Setting>** to change the ready/not ready criterion for controlling. These parameters can be adjusted to provide better pressure control by allowing a ready condition only when the FPG pressure is very stable.



*When the VLPC is active, the close bypass toolbar function and the **[Vent]** pressure option on the **<VLPC Interface>** window have the same function. VLPC control is aborted and all the FPG bypass valve is automatically opened.*

5.7.1 SETTING 0 PRESSURE

Setting zero pressure using the VLPC has a different meaning in the different measurement modes of the FPG. See Section 5.4 for information on how to set a measurement mode. Below is a list of measurement modes and the corresponding actions that FPG Tools takes when setting zero pressure. In all cases, the VLPC does not control zero pressure.

Gauge Mode	The FPG bypass valve is opened (upper and lower FPG chambers are connected together) and the VLPC pressure is vented. No special actions are taken with the optional DUT manifold. This is a true zero condition (see Section 5.2.1). The lubrication flow in the FPG does not induce a measurable pressure.
Absolute Differential Mode	The FPG bypass valve is opened (upper and lower FPG chambers are connected together) and the VLPC pressure is vented. If the optional DUT manifold is enabled, the manifold bypass valve is closed. Due to asymmetry in the flow in the manifold and the FPG, a differential DUT would not agree with the FPG pressure if both bypass valves are open. The measured FPG pressure will not be zero. A pressure results from the lubrication flow from the upper chamber through the bypass valve of the FPG to the reference vacuum pump. This pressure should be approximately the same in all ranges of the VLPC.
Absolute Mode	The FPG bypass valve is closed (upper and lower FPG chambers are isolated) and the VLPC pressure is vented. If the optional DUT manifold is enabled, the manifold bypass valve is closed. This is not the zero condition of the FPG therefore the pressure will not be zero. The lubrication flow through the active range restriction of the VLPC will induce a pressure in the upper FPG chamber. The higher the VLPC range, the higher the range restriction and corresponding zero pressure. In the lowest VLPC range, the pressure is typically less than 5 Pa and is typically greater than 100 Pa in the highest VLPC range.

5.8 LOGGING DATA WITH THE FPG

There are two data acquisition options provided by FPG Tools: **[Run w/Point Log]** and **[Run Test Sequence]**. Both options provide features for automatically gathering data from the FPG and any DUT that is set up. FPG Tools automatically acquires data from DUTs with an RS232 or IEEE-488 interface or prompts for the output of manual DUTs output. All data is written to a data file in a consistent format that is easily imported into other applications (see Section 9.2).



A separate data file is created for every active DUT. When no DUTs are active, only 1 data file is created.

The **[Run w/Point Log]** option allows discrete data points to be taken whenever desired, averaged for a specified amount of time, or taken automatically at fixed intervals by using the **[Take Point]**, **[Average Data]**, and **[Auto Point Log]** functions toolbar options respectively (see Sections 6.4.2 and 6.5.3). It is up to the test operator to set pressures and define control times for each point.

When a fixed sequence of points are required, use the **[Run Test Sequence]** option (see Section 6.5.4). Prior to selecting this menu choice make sure a test sequence is defined by using the **[Config]**, **[Test Sequence Editor]** option. This allows a list of target pressures to be specified along with averaging and dwell times (see Section 6.6.5).

5.9 SHUTTING DOWN THE FPG

Always shutdown the FPG when it will not be used for an extended amount of time or prior to performing maintenance operations. This reduces the risk of back pressurizing the system and contaminating internal pneumatic plumbing or the piston-cylinder.



If at any time the supply pressure to the FPG is reduced to ATM and the FPG is in gauge mode, water can be forced from the bubbling system into the main supply regulators and valves. This standing water will rapidly deteriorate these parts and prevent the FPG from functioning properly.



If at any time the pressure in the reference or test ports of the FPG exceeds the lubrication pressure, the lubricating flow will move in reverse from the mounting post to the lubricating volume. This typically results in a dirty piston-cylinder indicated by poor stability at zero.

Press the function toolbar **[Shut Down]** button (see Section 6.4.2) to shut down the FPG. FPG Tools sets the FPG to a zero condition (see Section 5.2.1) then vents all lubrication pressure. Only after the lubrication pressure is near ATM is the shutdown process complete. At this point it is safe to perform maintenance operations on the FPG. To resume normal operation, press the **[Shut Down]** button again or re-select the current pressure measurement mode in the **[Units]** menu.



6. FPG TOOLS

6.1 OVERVIEW

FPG Tools is a PC based application that provides the complete interface to the FPG and the VLPC. Without this software interface, only mechanical interaction is available with both of these instruments. Future versions of the FPG and VLPC will however, include complete front panel access to the instruments. For the present, FPG Tools must be used to monitor FPG pressure and to set pressures in the VLPC.

The output of the load cell and all internal sensors are polled and used to calculate the FPG pressure. The output of these devices can be viewed individually using the **<Diagnostics Display>** screen (see Section 6.3.7). Some of the sensor outputs are also available on the display of the FPG terminal.

The **<Run Display>** is the standard interface to FPG Tools and should be used in normal operation. The **<Ready Indicator>** will be green when the FPG pressure is “Ready” and red when the pressure is “Not Ready”.



Pressure is ready when there are no out of range errors in the system status and the FPG pressure is within the stability setting or hold limit, based on whether or not the VLPC is actively controlling.

All display windows can be selected by using the appropriate toolbar shortcut icon (see Section 6.4.1). Each window can be scaled and located on the screen in any fashion desired. The last size and position of each window is automatically used when FPG Tools is started.

Numerous discrete toolbar functions are available to perform common system operations in a single step (see Section 6.4.1). FPG Tools will adjust valves, monitor settings or control pressure as need to complete the operation.

Not only does FPG Tools calculate pressure for the FPG, it also provides data acquisition features that make it possible to log data from a DUT and define a test sequence. These functions can be actuated at anytime without interrupting the system. In fact, FPG Tools should be left running at all times whenever the FPG is in use.

The following sections describe the features and concepts implemented in FPG Tools. Refer to Section 5 for information on how to set up FPG Tools and how to use many common features in a practical environment.

6.2 MAIN MENU

FPG Tools contains a main menu like most Windows applications. Use the menu to enter a run mode or change the system settings. The toolbars provide a quick interface to all common operations of the program. The main menu contains the following options:

- [Run]** Provides selections for all run modes and the program exit. The run menu contains the options: **[Run Monitor]**, **[Run w/Point Log]**, **[Run Test Sequence]**, and **[Exit]** (see Section 6.5).
- [Config]** All selections related to the setup of the program are contained in this menu: **[Settings]**, **[System Setup]**, **[FPG Calibration Setup]**, **[Internal Limits]**, **[Test Sequence Editor]**, and **[Change User Level]** (see Section 6.6).
- [Units]** Use this menu to select existing pressure units, create user defined units and change measurement mode (see Section 6.8).
- [Plot Data]** This menu option is available only when a data acquisition run mode has been used and the **<Logged Points>** display contains data. Select a plot from the menu to refresh the **<Plot Display>** (see Section 6.3.4).
- [Tools]** The **[Remote Communications]** function auxiliary to the FPG System is available in this menu. The feature is useful in troubleshooting problems (see Section 6.11.1).
- [Window]** Active display windows can be arranged and selected using this menu.

6.3 MAIN DISPLAY

The main program contains several individually sizable display screens which can be viewed by using the corresponding toolbar shortcut (see Section 6.4.1). Use the close option (X) on the top right portion of any display screen to remove it from the view. FPG Tools remembers the last screen display when the program is closed. As a result, a user can customize the position and size of all windows one time. The custom view will be available in subsequent runs of the program. The status bar at the bottom of the main display should be viewed any time the state of the program is in question. Specific information on the intent and use of each display is listed in the following sections.



The status bar at the bottom of the main screen provides important run time information. Always refer to this bar while the FPG pressure is being monitored.

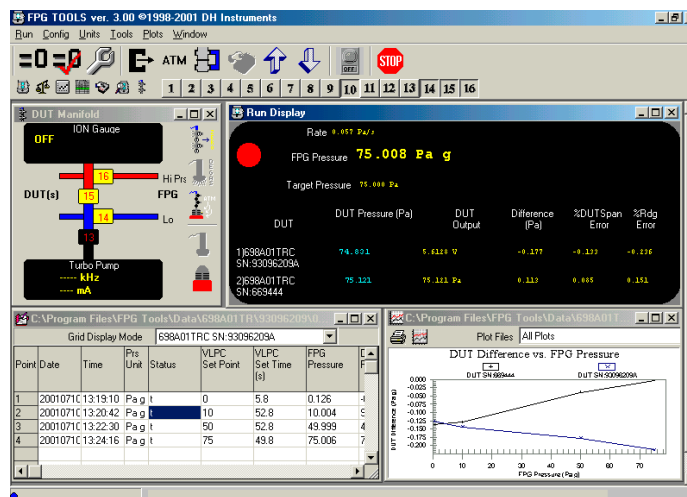

Figure 15. FPG Tools (Factory Mode)

6.3.1 STATUS BAR

The status bar located at the bottom of the main screen provides useful run-time information. This status bar has three distinct sections: run mode indicator, target action, and current action. The run mode indicator is a small blinking circle on the extreme left of the status bar. When this indicator is visible, FPG Tools is polling all support devices and updating the calculated FPG pressure. Each FPG remote operation changes the color and/or shape of this indicator. If for any reason the interface with the FPG is interrupted, the changes in state of this indicator will dramatically slow down. Changes will only occur at the 8s time out intervals used by the FPG. When the FPG pressure is very stable, it is difficult to determine if the system is operating properly without this indicator.

The current target action displays on the inset panel on the left side of the status bar. Common target actions include: zeroing, internal calibration, setting pressure, dwell and averaging. In the case that a re-zero criterion is exceeded a special *required* target will display in this field (see Section 6.6.4). This means the FPG must be re-zeroed in order to obtain a ready indication.

Current actions appear in the middle of the status bar. For a typical target action, there are several current actions that display to update the status of the target action. Each message is provided to inform the user of the current step in the target process.



Figure 16. <Status Bar>

6.3.2 RUN DISPLAY

The <Run Display> screen is the main visual user interface to the FPG. The FPG Pressure, ready indication, DUT pressures, DUT outputs and errors are available real time on this display. When simple pressure monitoring is selected, maximizing this display is recommended. This provides a large view of all of the pertinent outputs of the FPG.



Pressure is ready when there are no out of range errors in the system status and the FPG pressure is within the stability setting or hold limit, based on whether or not VLPC is actively controlling.



Double click the <Rate> and/or <FPG Pressure> fields to display a strip chart of the corresponding indicator.

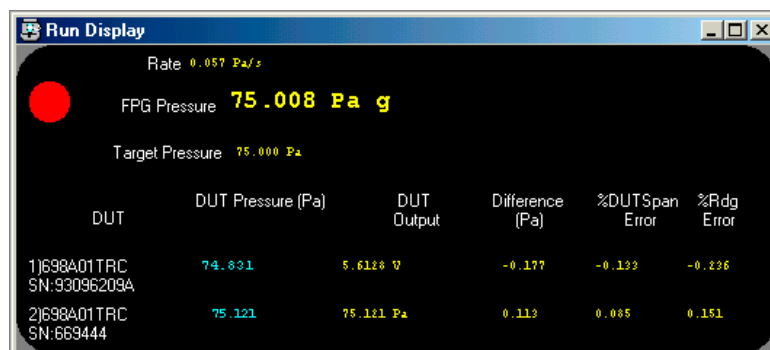

Figure 17. <Run Display>

A functional description of all display fields of the **<Run Display>** are included in the following table.

Table 5. <Run Display> Labels

LABEL	DESCRIPTION
Ready Indicator Red/Green circular indicator	A green light will display in this field when the FPG is Ready. This means that no status or limit related errors are present (see Section 6.3.7) and that the rate of change of FPG pressure is within the stability criterion when the VLPC is not actively controlling the FPG pressure. If the VLPC is controlling, the stability criterion is ignored, the hold limit is used as the final criterion for ready (see Section 3.6). If any of these criterion are not met, the indicator will be red which means the FPG is not ready.
FPG Pressure	The calculated instantaneous pressure of the FPG in the last selected pressure unit. If "--" appears in this display, the FPG pressure is not valid or not currently available. After the pressure and unit are a sequence of text tags to indicate the current operational state these tags are listed below: a – The FPG is in absolute measurement mode. ad – The FPG is in absolute differential measurement mode. g – The FPG is in gauge measurement mode. t – A thermal transpiration correction is being applied to the FPG pressure. h – A head correction is being applied to the FPG pressure.
Rate	The instantaneous FPG pressure rate of change per second in the last selected pressure units.
Target Pressure	The current VLPC target pressure. If the VLPC is disabled or is not controlling pressure, "N/A" displays.
DUT	The serial number of all active DUTs.
DUT Pressure	The calculated pressure based on the DUT pressure to output range setup (see Section 6.8) for all active DUTs. If no DUTs are enabled, dashes appear in this field. Double-click the DUT pressure to see a <Spy Window> that contains all of the commands and responses issued to the DUT. This can be useful when troubleshooting.
DUT Output	The direct output each active DUT formatted using the <Output resolution> specified in the DUT Setup (see Section 6.6.2.3).
%FS Error	The difference between the DUT and reference divided by the full scale value of the DUT times 100.
%Reading Error	The difference between the DUT and reference divided by the reference times 100.

6.3.3 TARE DISPLAY

The <Tare Display> always holds the last system zero information. All values in this display are used in the determination of FPG pressure. This data is stored even after FPG Tools is closed and when run mode is turned off. Realize that the stored information is not always valid. Several outside influences that are not detectable by the software can render the tare information invalid. It is best for a user to always re-zero the system prior to taking a new set of FPG data.



The FPG should be re-zeroed using FPG Tools any time the unit is turned off, handled by an operator, prior to a comparison with another device, or after changing measurement modes. Failure to follow this procedure may result in invalid pressure data.

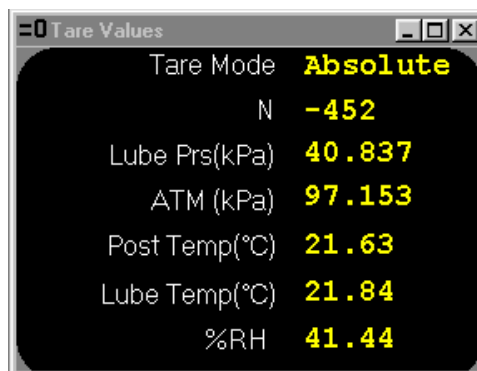

Figure 18. <Tare Display>

Table 6. <Tare Display> Labels

LABEL	DESCRIPTION
Tare Mode	This is the pressure measurement mode that was in effect when the system was last zeroed. The field is useful when the operation of the FPG will include changes in measurement mode.
N	The load cell output in counts just prior to setting the value to 0. After the FPG has been successfully tared in the active measurement mode, this value indicates zero drift since the last tare.
Lube Prs	The lubrication pressure in kPa at the time of tare.
ATM	The atmospheric pressure at the time of the last tare.
Post Temp	The mounting post temperature at the time of the last system zero.
Lube Temp	The lubrication volume temperature at the time of the last system zero. This value is used for reference purposes only and is not applied to any calculations.
%RH	The lubricating volume humidity at the time of the last tare.

6.3.4 PLOT DISPLAY

FPG Tools can be used to generate plots with data taken during **[Run w/Point Log]** and **[Run Test Sequence]** run modes. When point logging is enabled, use the **[Plots]** menu option to select a common plot based on the data points logged in the data grid (see Section 6.3.5). The **<Plot Data>** window also has a plot menu option that can be used to access new plots. As with any plot, at least two data points must be taken before a graph will appear on the plot display. All plots include axis labels and a plot header to describe the information used in generating the data plot. Press the **[Print]** toolbar icon to print the plot. As with the other run displays, the **<Plot Data>** window can be scaled and positioned as desired. Use the **[Custom Plot]** menu selection to plot data based on the available X and Y columns of data in the active test data file. Menu choices below the **[Custom Plots]** menu choice are used to create strip charts (see Section 6.3.4.1).

Use the **<Plot Files>** drop down list box to select the DUT data to plot. When multiple DUTs are used, an **<All Plots>** option is available to view data from all active DUTs. This option only displays data from one test cycle at a time. As a result, a multiple cycle test sequence will only display data from the active test cycle. Conversely, when a single DUT is selected, all test cycles display for the selected DUT. When **[Run w/Point Log]** is active, there is only one test cycle so all data is displayed for each DUT selected.

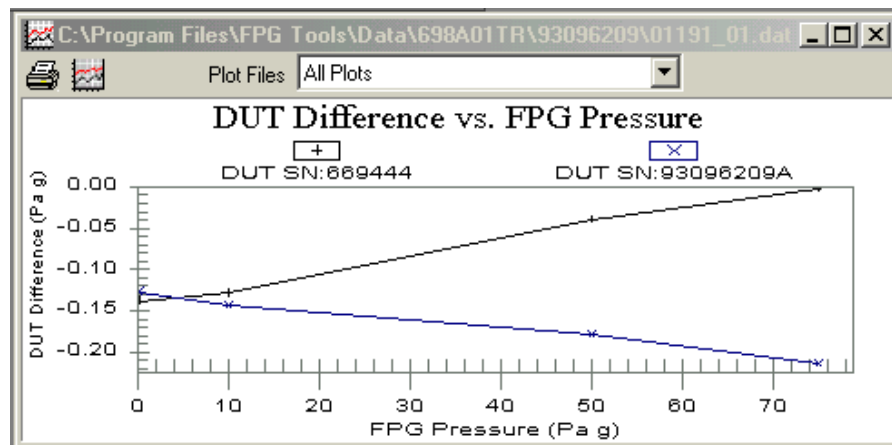

Figure 19. <Plot Data>

6.3.4.1 CUSTOM PLOTS

The plot menu and toolbar options contain a **[Custom Plots]** menu selection. This selection presents the **<Custom Plot Properties>** setup window. The top of the display contains a list of currently available custom plots. Double click any plot or select the plot then press the **[Plot Selection]** button to exit the window and plot the selected data. The bottom of the display allows custom plots to be edited, created and removed.

Figure 20 shows the **<Custom Plot>** display. Table 7 explains the features available on the display. Editing custom plots follows the same basic editing rules as all the **<Test Sequence Editor>** (see Section 6.6.5). The toolbar options always act on the currently selected custom plot. Edit plots by typing in any field. A flashing message displays to indicate that editing has begun. You must press the **[New]** toolbar option to create a new custom plot.

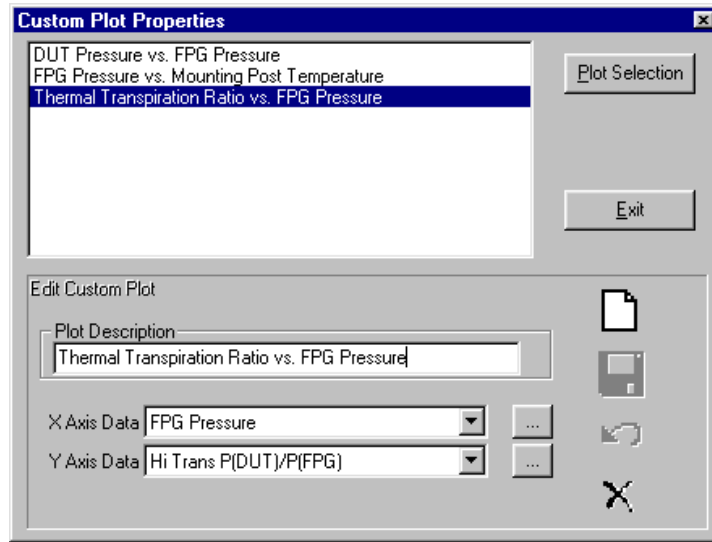

Figure 20. <Custom Plot Properties>

Table 7. <Custom Plot Properties> Tab Fields

FEATURES	DESCRIPTION
Plot Selection (button)	Press this button to plot the currently selected custom plot. Double clicking a custom plot in the list has the same effect.
Plot Description (text entry)	Enter text that describes the data that will be plotted. The text entered will appear in the list of custom plots and at the top of plots generated using this plot selection.
X Axis Data (list box)	Select the data that will display along the X axis. The text of the selection followed by units (when appropriate) will appear along the bottom of the plot. Press the button next to the drop down list to change the text to associated with <X Axis Data>. The exact text as entered will appear on the X axis of the plot
Y Axis Data (list box)	Select the data that will display along the Y axis. The text of the selection followed by units (when appropriate) will appear along the vertical axis of the plot. Press the button next to the drop down list to change the text to associated with <Y Axis Data>.

6.3.4.2 STRIP CHARTS

The FPG pressure and pressure rate can be updated on strip charts. Strip charts can be created without taking data by using the menu choices below the **[Custom Plot]** choice. Alternatively, double click the **<FPG Pressure>** or **<Rate>** fields on the **<Run Display>** to begin a strip chart. Strip charts display the most recent 200 updates of the FPG pressure values until 500 points have been taken. At this point, the strip chart is reset and continues updating starting with point number 1. Close the strip chart window to disable the strip chart function.

Strip charts are useful when trying to determine the stability of the FPG pressure. In some calibration scenarios, a needle valve must be used to compensate for the FPGs lubrication flow. In these situations, a user must isolate the DUT and adjust the needle valve so that the FPG pressure rate is effectively 0 prior to exposing the FPG to the instrument. A simple way to determine the effective rate is to look at a strip chart of the FPG pressure rate. If the rate is oscillating about 0 for 200 samples, it is fair to say that the rate is effectively 0.

6.3.5 LOGGED DATA

When **[Run w/Point Log]** or **[Run Test Sequence]** is used as the run option, data points can be logged to a user selectable data file and the logged data display. This display stores all relevant data regarding each point taken by the user. Each point represents a snap shot of all data found on the **<Run Diagnostics>**, **<Run Display>** and **<Tare Values>**. The title bar contains the file name of the data file used to store the test data. Other than the data file header, all test point information is logged to the data file in the same basic format as the data display. Refer to the calculation section of this manual for more information on the data logged on this grid. When **[Run] [Run Monitor]** is used, no data points will appear in this data grid and FPG Tools disables all options relevant to taking a data point.

The data file name defaults to the year, Julian day and run of the day in the format "YYDDD-R.dat". The third data file run on January 10, 2001 would use the default file name "01010-3.dat". To change the file name, edit the file name field of the file box that displays during initialization (see Section 9.2).



Use Table 8 as a key to help determine column information found in the data file.

Point	Date	Time	Prs Unit	Status	VLPC Set Point	VLPC Set Time (s)	FPG Pressure	DUT Pressure	DUT Output
1	20010710	13:19:10	Pa g t		0	5.8	0.126	-0.001	-0.0001
2	20010710	13:20:42	Pa g t		10	52.8	10.004	9.86	0.7396
3	20010710	13:22:30	Pa g t		50	52.8	49.999	49.821	3.7369
4	20010710	13:24:16	Pa g t		75	49.8	75.006	74.792	5.6099

Figure 21. <Logged Points> Display

Table 8. <Logged Points> Labels

LABEL	DESCRIPTION
Grid Display Mode	The model and serial number of all active DUTs display in this list box. When a selection is made, the grid is updated with data from the selected DUT.
Point	The number of the current data point.
Time/Date	Time and date of the current point. The time is formatted as a 24 hour value, "hh:mm:ss". The date format is year, month, day: "YYYYmmdd".
Pressure Units	The selected pressure units and measurement mode at the time the point was taken. This value will change with any new [Units] menu selection available. After the pressure unit are a sequence of text tags to indicate the current operational state these tags are listed below: a – The FPG is in absolute measurement mode. ad – The FPG is in absolute differential measurement mode. g – The FPG is in gauge measurement mode. t – A thermal transpiration correction is being applied to the FPG pressure. h – A head correction is being applied to the FPG pressure.
Status	This value contains any error status information present at the time the point is logged (see Section 6.3.7). Points that are averaged contain an accumulation of all individual error codes that occur over the course of the averaging cycle. This information can be used to troubleshoot aberrant points.  <i>Pressure is ready when there are no out of range errors in the system status and the FPG pressure is within the stability setting or hold limit, based on whether or not VLPC is actively controlling.</i>
VLPC Target Pressure	The last set target pressure when the VLPC is in use. If a pressure target was not set, the field displays "N/A"
Set Time	The time to reach stability after the last VLPC target pressure was set. If a point is taken prior to reaching stability or the VLPC is not actively controlling, the field displays "N/A".
FPG Pressure	The calculated FPG pressure in the pressure units listed in the <Pressure Units> column. For averaged data points, the averaged FPG pressure is logged.
DUT Pressure	The calculated DUT pressure in the pressure units listed in the <Pressure Units> column.
DUT Output	The output of the DUT in the output units set up in the DUT configuration (see Section 6.6.2.3).
DUT Difference	The difference between the DUT pressure and the FPG pressure in the pressure units listed in the <Pressure Units> column. When a DUT is not enabled, "----" displays in this field.
DUT %FS Error	The difference between the DUT and reference divided by the full scale value of the DUT times 100.
%Reading Error	The difference between the DUT and reference divided by the reference times 100.
FPG Min Pressure	The minimum FPG pressure logged as the result of an averaging cycle (see Section 6.4.2). The value can be used to quantify control noise over the course of an averaging cycle. For non averaged points, the instantaneous FPG pressure is logged. In this case the value logged is the same as the <FPG Pressure> field.
FPG Max Pressure	The maximum FPG pressure logged as the result of an averaging cycle (see Section 6.4.2). The value can be used to quantify control noise over the course of an averaging cycle. For non averaged points, the instantaneous FPG pressure is logged. In this case the value logged is the same as the <FPG Pressure> field.
STD FPG Pressure	The standard deviation of the FPG pressure in the current pressure units over the course of an averaging cycle (see Section 6.4.2). The value can be used to quantify control noise over the course of an averaging cycle. For non averaged points, "N/A" displays.
Tare Mode	The measurement mode used for the system zero that was in effect when the point was taken: g or a for gauge and absolute respectively.
N	The direct load cell output in counts.

LABEL	DESCRIPTION
$\delta N1$	Correction factor due to the change in lubrication pressure since the last system zero (see Section 2.7.1). The value represents the change of buoyancy force on the load cell.
$\delta N2$	Correction factor due to the relative change in lubrication pressure and reference pressure since the last system zero. The value represents the change in drag force on the piston (see Section 2.7.2).
$\delta N3$	Correction factor due to the change in the reference pressure (atmosphere or vacuum) after the last system zero. The value represents the change in buoyancy force due to the reference pressure (see Section 2.7.3).
Head Correction	Pressure error associated with the difference between the reference level of the DUT and FPG. The value is automatically applied to the FPG pressure.
K_Cal	Calibration factor in effect when the point was taken. This value will change if an internal calibration is performed between points either discretely or as the result of a tare (see Section 5.3).
Effective Area	Effective FPG area based on the current temperature (see Section 11.3).
Residual Pressure	Instantaneous or averaged residual pressure in Pa as output by the vacuum reference sensor when it is enabled (see Section 6.6.2.1). When it is not enabled, 0 Pa is always used. This value is only relevant when the FPG is being used in absolute mode. Gauge mode reference pressure is ATM. Absolute differential mode can display a value, but not apply it to the FPG pressure.
ATM Pressure	Instantaneous or averaged atmospheric pressure in kPa.
ATM (0) Pressure	Atmospheric pressure logged during the last tare. Same as the value found on the <Tare Display> (see Section 6.3.3). This value can change if the system is re-zeroed between points.
Lube Pressure	Instantaneous or averaged lubrication pressure in kPa.
Lube (0) Pressure	The lubrication pressure when the system was last zeroed. Same as the value found on the <Tare Display>. This value can change if the system is re-zeroed between points.
Post Temp	Instantaneous or averaged mounting post temperature in °C. Each mounting post temperature value is an average of both mounting post PRTs.
Post Temp Rate/m	The rate of change per minute of the mounting post temperature in °C/m.
Post Temperature (0)	The mounting post temperature at the time the system was last zeroed. This value can change if a re-zero occurs between points.
Lube Temp	Instantaneous or averaged lubricating volume temperature in °C.
Lube Temp Rate/m	The rate of change per minute of the lubricating volume temperature in °C/m.
Lube Temperature (0)	The lubricating volume temperature at the time the system was last zeroed. This value can change if a re-zero occurs between points.
%RH	Instantaneous or averaged relative humidity.
%RH/m	The rate of change per minute of the humidity measured in the lubricating volume.
%RH (0)	The relative humidity logged at the time the system was last zeroed. This value can change if a re-zero occurs between points.

6.3.6 VLPC CONTROL

This window is the interface to the VLPC. If the **[Config]**, **[System Setup]**, **<Setup>**, **<Enable VLPC>** option is selected, the window is available for input in all run modes. Use the tools on this display to: change range, vent pressure, abort control or set a new target pressure. After each operation is executed, the window is disabled until the operation is complete.



Use the <Operation Abort> toolbar function to abort operations that you do not want to complete. However, this may leave the system in an undefined state. So make sure that a new range is set or the pressure is vented if an early abort occurs.



Although the VLPC control window is available during the execution of a test sequence (see Section 6.6.5), it is recommended that the controls not be used to prevent corruption of the test sequence.

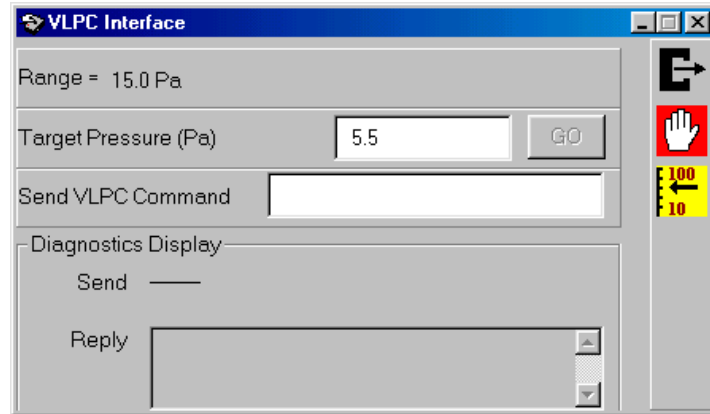

Figure 22. <VLPC Interface>

Table 9. <VLPC Interface> Options

LABEL	DESCRIPTION
Vent (Button)	This function vents the system pressure and opens the bypass valve. The FPG/VLPC and any DUT connected is left in a safe condition when this operation is complete.
Abort (Button)	Aborts VLPC control. This means the VLPC will no longer dynamically control system pressure. The last internal control point is left constant in the VLPC which typically results in a stable FPG pressure.
Range (Button)	When activated, a popup window allows the selection of the desired pressure range. All pressure range values are listed in the current pressure display unit as the approximate lowest <i>controllable</i> point for that range to the range full scale value. Click the button that represents the desired pressure range. The current pressure is vented, then the new pressure range will be set automatically. The process takes about 30s depending on the current state of the system. The default hold limit specified for the selected range is automatically set when the range change is complete. Default hold limits are specified using the [Internal Limits] option (see Section 6.6.4.7). <div data-bbox="812 1373 1235 1684" data-label="Image"> </div>
Range (Label)	Displays the last set range of the VLPC.
Target Pressure (Entry Field)	Enter the desired target pressure in the displayed units then press the [Enter] key or the [Go] button to set the pressure. The value displayed in this field always represents the current target pressure when the VLPC is actively controlling pressure. A "D" in the status indicator always notes VLPC control.

Figure 23. <Select VLPC Range>

6.3.7 RUN DIAGNOSTICS

When FPG Tools is in run mode, all information on this display is continually updated. The goal of this run screen is to provide a compact view of all discrete outputs used in calculating the FPG pressure as well as the main calculation components. Table 10 lists specific information on the <Diagnostics Display> screen labels.



Pressure is ready when there are no out of range errors in the system status and the FPG pressure is within the stability setting or hold limit, based on whether or not VLPC is actively controlling.



Double click the <Rate> and/or <FPG Pressure> fields to display a strip chart of the corresponding indicator.

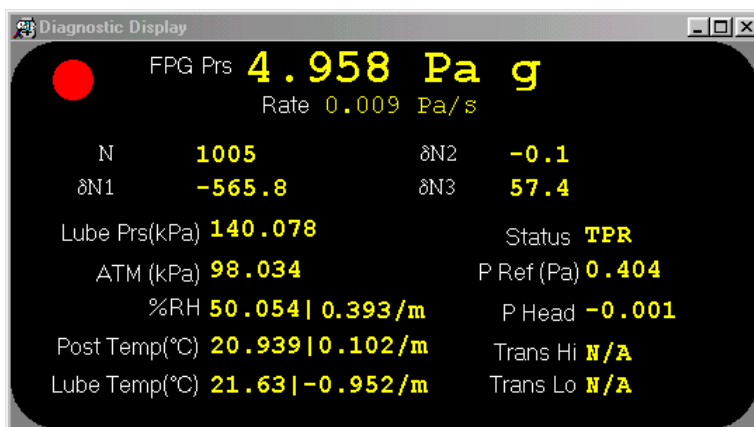



Figure 24. <Diagnostics Display>

Table 10. <Diagnostics Display> Options

LABEL	DESCRIPTION
FPG Prs	The calculated FPG pressure in the currently selected display units. When FPG Tools is in a run mode, this field is updated every time a relevant calculation value is updated. Use the [Units] menu to change the display units and/or measurement mode. After the pressure and unit are a sequence of text tags to indicate the current operational state these tags are listed below: a – The FPG is in absolute measurement mode. ad – The FPG is in absolute differential measurement mode. g – The FPG is in gauge measurement mode. t – A thermal transpiration correction is being applied to the FPG pressure. h – A head correction is being applied to the FPG pressure.
Rate	The instantaneous FPG pressure rate of change per second in the last selected pressure units.
Ready Indicator Red/Green circular indicator	A green light will display in this field when the FPG is Ready. This means that no status or limit related errors are present and that the rate of change of FPG pressure is within the stability criterion when the VLPC is not actively controlling the FPG pressure. If the VLPC is controlling, the stability criterion is ignored, the hold limit is used as the final criterion for ready (see Section 3.6). If any ready criterion is not met, the indicator will be red which means the FPG is not ready.
DUT Pressure	The calculated DUT pressure based on the DUT pressure to output range setup (see Section 6.6.2.3). If the DUT is not enabled, dashes appear in this field.
DUT Output	The direct output of the DUT formatted based on the <Leading characters to strip> and the <Output resolution> specified in the DUT Setup.

LABEL	DESCRIPTION
N	Load cell output in counts (mg). When the load cell is unstable, a red dot will appear next to this display and a B will be logged in the <Status> field. Note that the load cell is automatically zeroed when the FPG is turned on.
$\delta N1$	Correction factor due to the change in lubrication pressure since the last system zero (see Section 2.7.1).
$\delta N2$	Correction factor due to the relative change in lubrication pressure and reference pressure since the last system zero (see Section 2.7.2).
$\delta N3$	Correction factor due to the change in the reference pressure (atmosphere) after the last system zero (see Section 2.7.3). In absolute mode, this value is zero provided the last zero was also in absolute mode.
Lubrication Pressure	The lubrication pressure in kPa as read by the internal transducer. This value is updated approximately every 1s to re-calculate the <FPG Prs> .
ATM	The atmospheric pressure as read by the FPG internal transducer. Internal valves are switched to read this pressure based on the <Lubrication Switch Time> value (see Section 6.6.4). The pressure is updated in gauge mode only and when the [ATM] toolbar function is used.
Reference Pressure	<p>This output is provided in gauge to absolute mode transition only. During the transition, the internal transducer is switched to read the pressure in the reference port to make sure the reference vacuum is activated. The output of the transducer during this transition displays in this field.</p> <hr/> <p> Do not confuse this pressure with the vacuum reference pressure read by the vacuum reference sensor.</p> <hr/>
P Ref	The pressure output by the vacuum reference sensor. This value is updated approximately every 1s when the residual vacuum is active. This value can be activated or deactivated by using a [Config],[System Setup],[Setup] option (see Section 6.6.2.1). The reference pressure is used in absolute mode operation only (see Section 2.5). When no residual pressure device is set up the field displays "----".
Post Temp	<p>The average temperature of the mounting post PRTs in °C. When the difference between the current temperature and the tare value becomes larger than the temperature re-zero limit, the FPG must be re-zeroed before a "Ready" indication can be achieved (see Section 6.6.4.3).</p> <p>The second field in this display represents the average temperature rate of change over the last minute. If this rate exceeds the rate of change limit, a re-zero warning will display on the status bar and the FPG will indicate a "Not Ready" condition.</p>
Lube Temp	<p>The temperature measured by the lubricating volume PRT in °C. If the difference between this temperature reading and the reading of the <Post Temp> differ more than the re-zero limit, the FPG must be re-zeroed (see Section 6.6.4.3).</p> <p>The second field in this display represents the average temperature rate of change over the last minute. If this rate exceeds the rate of change limit, a re-zero warning will display on the status bar and the FPG will indicate a "Not Ready" condition.</p>

LABEL	DESCRIPTION
<p>Status</p>	<p>The status of the current point. The field can be considered an exploded view of the ready/not ready indication of the FPG. Do not confuse this label with the status bar found at the bottom of the main program window. This text field may contain a combination status information codes that indicate one or more internal limits have been exceeded. In most cases, zeroing the FPG will remedy the problem. With the exception of "R", any status code forces a "Not Ready" condition in the FPG.</p> <hr/> <p> <i>Any value present in the status field with the exception of "R", forces a "Not Ready" condition in the FPG ready indicator. In most cases, re-zeroing the FPG is all that is required to remedy the problem.</i></p> <hr/> <p>A – The ATM pressure exceeds the stability limit or the value is invalid. When an A appears, the FPG pressure is not updated regardless of the output of the load cell and other FPG sensors. Use the <ATM> toolbar function to force the reading of atmosphere.</p> <p>L – The lubrication pressure exceeds the stability limit. This should only be a momentary indication. If it persists, there may be a leak the system or the supply pressure to the regulator could be running low.</p> <p>B – The load cell has an unstable output or has an invalid reading. This is also indicated by a red dot next to the <N> value on the <Diagnostics Display>. Since this value represents noise levels beyond the resolution of the FPG, this indicator does not cause a "Not Ready" condition when present.</p> <p>T – The mounting post or lubricating volume temperatures have changed beyond the tare limit (see Section 6.6.4.3), the relative difference between the mounting post and lubricating volume temperatures differ beyond the acceptable limit, or the rate of change of any temperature indicator exceeds the re-zero limit. The system should always be re-zeroed if this occurs.</p> <p>t – At least one active DUT is out of tolerance relative to the FPG (see Section 6.8.2.4).</p> <p>R – Indicates the FPG pressure is not ready based on the current stability and hold criterion or other status indicators (see Section 3.6).</p> <p>H - The humidity value has changed beyond the humidity tare limit or the rate of change of humidity exceeds the specified humidity rate (see Section 6.6.4.4).</p> <p>E - An error exists in the FPG calculation or output of one of its internal sensors. Calculation errors occur when some of the variables used in calculating the FPG pressure contain values that generate a math error. When this occurs, no final FPG pressure value is calculated.</p> <p>I – One or more of the FPG calculation components is invalid. When this occurs, the FPG pressure is not calculated.</p> <p>P – The lubrication pressure has changed from its zero value more than the re-tare limit. The system should be re-zeroed when this occurs.</p>
<p>Status (continued)</p>	<p>V - The FPG is in absolute mode and the vacuum reference pressure is unstable. This indication should be momentary. If it persists, there may be a leak on the reference port, or the vacuum reference stability criterion is too restrictive (see Section 6.6.4.2).</p>
<p>%RH</p>	<p>Instantaneous lubricating volume humidity.</p>
<p>P Head</p>	<p>The effective head correction in the active FPG pressure unit. Use [Config].[Settings] to change the head height value (see Section 6.6.1).</p>
<p>Hi Trans P(DUT)/P(FPG)</p>	<p>Thermal transpiration correction ratio based on the absolute pressure in the upper chamber of the FPG. The ratio is the effective DUT pressure divided by the absolute FPG pressure in the upper mounting post.</p>
<p>Lo Trans P(DUT)/P(FPG)</p>	<p>Thermal transpiration correction ratio based on the absolute pressure in the lower chamber of the FPG. The ratio is the effective low side DUT pressure divided by the absolute FPG pressure in the lower mounting post.</p>

6.3.8 DUT MANIFOLD

When the optional DUT manifold is active in the system setup, the <DUT Manifold> display is available to monitor and control the devices connected to the manifold. When the vacuum pump and ion gauge are active, their outputs display at the top and bottom of the form. Activate the manifold and associated devices by using the **[Config]**, **[System Setup]**, **[Options]** see Section 6.6.2.2. When a device is activated, it is available for use by FPG Tools. It does not mean that the device is automatically turned on. Use the manifold toolbar to control the vacuum pump and ion gauge as need.

The manifold display also acts as a pressure schematic. Based on the state of the valves on the manifold display, the colors of the connecting tubes will change to reflect the current pressure. Table 11 lists the colors and their correspondence to pressure. Double-click any valve to toggle the current activation state.



Do not toggle valves on the DUT manifold without considering the impact the changed state may have. In some cases, a large pressure differential may exist. This can damage any device pneumatically connected to the manifold, including the FPG.

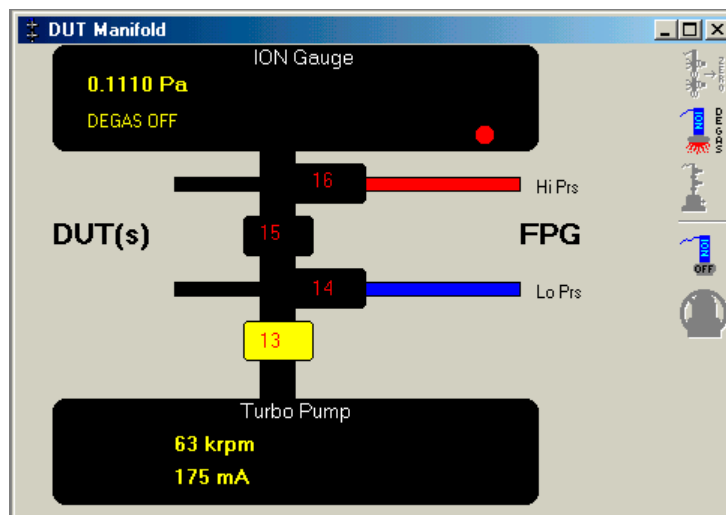







Figure 25. Window Display Toolbar

Table 11. <DUT Manifold> Color Scheme

COLOR	DESCRIPTION
Red	Pressure from the upper chamber of the FPG.
Blue	Pressure from the lower chamber of the FPG.
Black	Vacuum pressure generated by the manifold vacuum pump.
Gray	The current pressure state is undefined. This typically occurs when valves are adjusted to completely isolate the gas.

Table 12. <DUT Manifold> Display

LABEL	DESCRIPTION
Ion Gauge	The pressure and degas state of the ion gauge display in this field. The red/green indicator is available when zeroing. This indicator is changed to green after the ion gauge has successfully completed degassing.
Turbo Pump	The rotation speed and current of the manifold vacuum pump display in this field.
Zero DUT Manifold 	Executes the manifold zero process (see Section 5.6). The manifold is isolated from the FPG and subjected to a hard vacuum. This feature is intended to be used with devices that must be zeroed in low absolute conditions.
Degas Ion Gauge 	Toggles the state of the ion gauge degas option. When the ion gauge pressure is low enough (approximately 6 MPa) degassing can be turned on. If the pressure is above this limit, the ion gauge automatically turns off degassing. The ion gauge automatically turns on degassing when the process is complete.
Vent Vacuum Pump 	Vents the vacuum pump by opening the pump's vent valve for 2s every 10s for 30s. This prevents a large flow of air on the turbo pump. If the pump is spinning at high speeds, a large rush of air can damage the pump over time.
Turn On/Off Ion Gauge 	Turns on or off the ion gauge. The manifold vacuum should be on and spinning at approximately 63 krpm before attempting to turn the pump on. The ion gauge must be active in the system setup and powered on for this option to be available.
Turn On/Off Vacuum Pump 	Turns on or off the vacuum pump. It is best to vent the pump when it is turned off. The turbine inside the vacuum pump will spin for several hours if not vented. The manifold vacuum isolation valve (13) is not toggled when this option is used.

6.4 TOOLBARS

There are three main toolbars used by FPG Tools: the window display toolbar, valve control toolbar and the function toolbar. The window display toolbar is used to display any of the various program run screens. This is the smallest of the three toolbars and is available at all times. The other toolbars are only available when FPG Tools is in a run mode (see Section 6.5). The valve control toolbar is available only when FPG Tools is executed in the Diagnostics user level (see Section 6.10).







6.4.1 WINDOW DISPLAY TOOLBAR

This toolbar is used to display any of the various FPG run screens. When a toolbar item is selected, the corresponding run screen displays in the last stored position. This could be outside the display area of the main program. As a result, it may be necessary to scroll the main display to view the selected run screen.



Figure 26. Window Display Toolbar

Table 13. Window Display Toolbar Options

ICON	DESCRIPTION
	Activates the <Run Display> (see Section 6.3.2).
	Activates the <Tare Display> (see Section 6.3).
	Activates the <Plot Display> (see Section 6.3.4).
	Activates the <Logged Points> window (see Section 6.3.5).
	Activates the <VLPC Interface> window (see Section 6.3.6).
	Activates the <Diagnostics Display> window (see Section 6.3.7).
	Activates the <DUT Manifold> window (see Section 6.3.8).





6.4.2 FUNCTIONS TOOLBAR











The features on the Function Toolbar are enabled only when FPG Tools is in a run mode. Then features specific to the current setup and run mode selected are enabled. For this reason, some toolbar functions will not be available in some run modes. The following sections detail the purpose and use of each of the available toolbar functions.





















It is good practice to initiate only one function at a time. Due to timing factors with other internal operations it may take several seconds before the selected function takes place. Watch the <Status Bar> to monitor the state of the function when applicable. Use the [Operation Abort] toolbar function to exit any functions that you do not wish to complete.

Table 14. Functions Toolbar Option

ICON	DESCRIPTION
 [Move Back]	When a test sequence is the active run mode (see Section 6.5.4), this function returns the test sequence control to the beginning of the most recent pressure target. If immediately pressed again, execution resumes with the target pressure of the previous test point. Points are stepped back all the way to the beginning of the test sequence. The <Logged Points> window highlights the row of the new point with each selection.
 [Move Forward]	When a test sequence is the active run mode, this function allows repeated points to be skipped. Repeatedly pressing this button automatically skips test execution to the next previous logged point until an incomplete point is encountered. When the highest test point logged in the test sequence is reached, the option is automatically disabled. The <Logged Points> window highlights the row of the new point with each selection.
 [Sequence Pause]	Use [Pause] to temporarily disable any automatic dwell or averaging time during a test sequence. Press the button again to continue. This option is not available in any other run mode. Pressure targets and data averaging are not affected by the pause state.
 [Take Point]	This feature is enabled only when the [Run w/Point log] option is in use. When pressed all relevant instantaneous FPG and DUT calculation information is logged to the data file and the <Logged Points> run screen (see Section 6.3.5). Use this function to take points when a test sequence is not desired. If a manual entry DUT is currently enabled, a prompt to enter the DUT output will occur prior to logging the point. Make sure the DUT output is entered in the configured DUT output units (see Section 6.8).

ICON	DESCRIPTION
 <p>[Enable Auto Log]</p>  <p>[Disable Auto Log]</p>	<p>When first selected, [Auto Log] will be turned on. A prompt will appear allowing the entry of a delay time in seconds. FPG Tools will automatically take a point every delay interval seconds until this button is pressed again. This is identical to manually taking points based on a specific time interval. Automatically logging points can be useful when monitoring the effects of slowly evolving phenomenon or monitoring long-term system stability and control.</p> <hr/> <p> <i>Pay special attention to the status column of logged points when extremely long automatic point logging is used. Changes in conditions may render the FPG pressure invalid.</i></p> <hr/> <p> <i>If a manual entry DUT is currently enabled, a prompt to enter the DUT's pressure will occur each time a point is logged. If this is not desired, disable the DUT before enabling [Auto Log].</i></p>
 <p>[Average Data]</p>	<p>When selected, FPG Tools averages all logged data for the averaging time specified then writes the results to the data file and the <Logged Points> run screen. If a manual entry DUT is currently enabled, a prompt to enter the averaged DUT pressure will occur <i>after</i> the averaging cycle is complete. The drop down arrow next to the main icon displays a menu with the current averaging time and the option to enter a new averaging time. By default the value is 5s but it can be changed to any value ≥ 1 and ≤ 1000.</p>
 <p>[Plot Data]</p>	<p>Plots data currently logged in the data grid. The option is effectively a shortcut to the [Plots] menu option. The toolbar function is not available in the [Run Monitor] run mode (see Section 6.5.2). In this case, if data is present in the data grid the [Plots] menu option should be used to generate new data plots.</p> <p>Only one plot will display at a time in the plot display form. The plot can be scaled or printed as desired (see Section 6.3.4). Any plot active at the time a point is logged is automatically updated with the information of the current point.</p>
 <p>[Zero System]</p>	<p>Use this option to zero (tare) the FPG. The load cell output is set to zero and the condition of all sensors are logged to calculate correction factors (see Section 2.7). All zero information displays on the <Tare Display>. To zero the system, FPG Tools automatically attempts to set the zero conditions based on the current measurement mode. When set, the zero information is logged only after a successful stability check. Details on the procedure for zeroing are described in Section 5.2</p> <hr/> <p> <i>To ensure that a valid zero is obtained, make sure any DUT connected to the system does not connect the high and low reference ports of the FPG.</i></p>
 <p>[Zero Check]</p>	<p>Use this option to check the zero of the FPG. FPG Tools sets the zero condition and waits for stability in the FPG. Any zero error is indicated by the current pressure at this time. With a few exceptions, all other program functions are disabled during the zero check. Use the [Zero System] icon during the zero check to zero the FPG without again waiting for stability. FPG Tools will remain in the zero check mode until the [Operation Abort] icon is pressed.</p> <hr/> <p> <i>Do not allow a zero check to continue more than 5 minutes in absolute mode. The lubrication pressure will build up in the mounting post and eventually reverse pressure the system.</i></p> <hr/> <p>In gauge mode, [Zero Check] and [Close Bypass Valve] have the same function. This feature is intended for use in absolute mode.</p>

ICON	DESCRIPTION
 <p data-bbox="407 327 527 373">[Internal Calibration]</p>	<p data-bbox="553 247 1409 346">Activates the internal calibration process that is used to correct the slope of the FPG by comparing the current output of the load cell with the output of a known mass. The relative error between the readings is used to determine a new calibration factor for the FPG. Refer to Section 5.3 for details on the internal calibration process.</p> <p data-bbox="553 352 1409 430">The results of the internal calibration display with the option to: activate the new calibration, log the calibration information to the calibration log file print the calibration or simply to cancel.</p> <hr/> <p data-bbox="553 462 1409 535"> <i>An internal calibration must be executed every time the pressure measurement mode is changed. Failure to do so will result in an FPG span error.</i></p> <hr/> <p data-bbox="553 567 1409 640"> <i>The internal calibration process can automatically be performed with each system zero if the <Auto run internal calibration > option is selected (see Section 6.6.2.1).</i></p>
 <p data-bbox="370 747 527 772">[Purge System]</p>	<p data-bbox="553 667 1409 787">Activates the purge sequence to hasten the process of obtaining stable conditions within the lubricating volume. Purging is frequently required when changing measurement mode and after initial FPG startup. The FPG lubricating volume is cycled in pressure a number of times until the change in relative humidity inside the load cell reduces to a value within the factory limit.</p>
 <p data-bbox="407 879 527 905">[Read ATM]</p>	<p data-bbox="553 800 1409 945">Press this button to force an atmospheric measurement. Internal valves are actuated to expose the internal pressure transducer to atmosphere until a stable value is obtained. The valves are then actuated to expose the transducer to the lubricating volume pressure for normal operation. Error associated to typical changes in atmosphere are not significant while error associated to changes in lubrication pressure can be significant (see Section 2.7).</p> <p data-bbox="553 951 1409 1071">During normal operation, atmosphere is refreshed when gauge mode is set and at intervals based on the <ATM/Lube Switch Delay> (see Section 6.6.4.1), which is typically set to about 15 minutes. As a result, the display of atmosphere on the <Diagnostics Display> is not a real time update. If a faulty reading is ever made, the error would persist for several minutes. Use this function to update the value.</p>
 <p data-bbox="381 1167 527 1213">[Open Bypass Valve]</p>	<p data-bbox="553 1087 1409 1165">Opens the FPG bypass valve. This function effectively, isolates the high and low ports of the FPG. Before a manual pressure can be set, this feature must be used to allow a differential pressure on the FPG piston-cylinder.</p> <hr/> <p data-bbox="553 1197 1409 1270"> <i>The icon on the toolbar does not represent the current state of the bypass valve. Instead, the icon represents the action the function will carry out.</i></p>
 <p data-bbox="381 1404 527 1451">[Close the Bypass Valve]</p>	<p data-bbox="553 1325 1409 1423">Closes the FPG bypass valve. Use this icon to manually return to a zero condition. In absolute mode, the leak of lubrication pressure through the bypass to the reference port induces a differential pressure. To view 0 differential pressure in absolute mode the vacuum reference must also be shut off by deactivating valve 9 (see Section 5.2.1).</p>
 <p data-bbox="381 1537 527 1583">[Open Control Reference]</p>	<p data-bbox="553 1457 1409 1556">Activates the FPG control reference valve 11 (see Figure 13). When the VLPC is activated, this feature is disabled and control of the valve is based on the active VLPC range. When zeroing the FPG, the valve is automatically closed for the duration of the zero and opened if the valve was activated at the beginning of the zero.</p>
 <p data-bbox="381 1669 527 1715">[Close Control Reference]</p>	<p data-bbox="553 1589 1409 1646">Deactivates the FPG control reference valve 11. When the VLPC is activated, this feature is disabled and control of the valve is based on the active VLPC range.</p>
 <p data-bbox="349 1801 527 1848">[Raise Internal Calibration Mass]</p>	<p data-bbox="553 1722 1409 1799">Removes the internal calibration mass from the measuring mechanism of the load cell. The process takes approximately 10s. During this time, the FPG pressure is not valid. This function is available in advanced user level only (see Section 6.10).</p>

ICON	DESCRIPTION
 [Lower Internal Mass]	<p>Lowens the internal calibration mass onto the measuring mechanism of the load cell. The process takes approximately 10s. During this time, the FPG pressure is not valid. When the mass is lowered, the load cell output will change by the weight of the internal calibration mass. The calculated FPG pressure will also change accordingly. This is a diagnostics tool only available in the advanced user level.</p>
 [Shut Down FPG]	<p>This function should be used to vent all lubrication pressure from the lubricating volume. Without lubrication pressure, the piston cannot be sensitive, therefore the FPG is effectively shut down. Use this function prior to disassembling the FPG. The icon image will change after the function is selected.</p> <hr/>  <p><i>Always shutdown the FPG when it will not be used for an extended amount of time. This will help to avoid contaminants between the piston and cylinder.</i></p>
 [Restart FPG]	<p>Re-activate the FPG by setting the last used pressure measurement mode. The function has the same effect as directly selecting a measurement mode. When the process is complete, the lubricating volume is pressurized according to the measurement mode.</p>
 [Abort Run Mode]	<p>Abort is used to abort the active run mode and return to an idle state. The FPG pressure is automatically vented and the bypass valve is opened as part of the abort process. Prior to aborting, a message allows the abort to be canceled if the option was not selected intentionally. When this function is selected during a test sequence, an option is available to resume program control with the run monitor opposed to completely returning to an idle state. The program control box close option X and the [Run], [Exit] option perform the same function as the [Abort Run Mode] option when FPG Tools is in a run mode.</p>
 [Operation Abort]	<p>This feature is enabled only when potentially long program functions are in progress. This includes: zeroing, changing measurement mode, running an internal calibration, purging and reading atmosphere. When this option is selected, only the current operation is aborted, FPG Tools will remain in the current run mode. The option is best used when a function is started that the system will not be able to complete due to a setup error. Abort the operation, complete the necessary setup, and then retry.</p> <hr/>  <p><i>Aborting internal calibrations can leave the FPG in a state in which the internal calibration mass is lowered and the calibration is complete. FPG Tools makes every attempt to avoid this condition, however, repeated aborts by the user may result in this condition. To abort the internal calibration, press the [Operation Abort] option one time only.</i></p>

6.4.3 VALVE CONTROL

FPG Tools automatically performs all necessary valve changes based on the requirements of the current pressure measurement mode and the requested operation. Normal system operation does not require understanding or use of any of the FPG internal valves. For quick steps in diagnosing problem, FPG Tools displays the state of the 16 supported valve drivers in **Factory Mode** only. Valves 1 through 11 are used by the FPG on a regular basis. Valves 13 to 16 are extra valves not needed in the general FPG/VLPC configuration. Refer to Section 11.1 for information on the internal valves and their function. Click the number of any of the desired valves to toggle its actuation state. A depressed button means the valve is actuated while the normal state means the valve is in its normal state. There is typically a small delay between the time the valve option is selected and the time the valve actually changes state. The valve toolbar display is refreshed with the state of the valve only after the state change occurs.



During normal system operation, FPG Tools performs all of the necessary valve operations based on the pressure measurement mode and requested operation. The ability to change valve states is provided for diagnostics purposes only.



Changing valves manually can place the FPG in an unstable situation possibly causing a system overpressure or forcing the lubrication pressure back into the lubricating volume. Manual valve operation is provided for diagnostics purposes only and requires a thorough understanding of the function of each valve in the system. Most invalid valve configurations can be remedied by re-selecting the measurement mode.



Figure 27. Manual Valve Control Toolbar

6.5 [RUN]

The **[Run]** menu contains options related to monitoring the output of the FPG. Use these options to put FPG Tools into a run mode. When FPG Tools is not in a run mode, the program is considered to be idle. This means the state of the FPG and VLPC are not being monitored by the program. There are three basic run modes: **[Run Monitor]**, **[Run w/Point Log]**, and **[Run Test Sequence]**. Before entering any of the run modes for the first time, the system must be initialized to synchronize FPG Tools with the states of the FPG and VLPC.



To abort any run mode use the toolbar **<Abort>** option or any of the main program exit options.

The premise of a run mode is to put FPG Tools in a state in which the PC software behaves like a common stand alone instrument with multiple discrete function keys. Use any of the control toolbars to set pressures, change displays, change pressure units and measurement mode, log points (if supported) or repeat data points (if supported). Most program configuration options can also be changed while in a run mode. It is possible to create and use a new DUT or disable an active DUT without ever exiting a run mode. Run modes themselves can be selected at any time without aborting the active run mode.



Run modes do not need to be aborted prior to making configuration changes or selecting a new run mode. However, it is recommended that configuration changes should not take place after a run mode is selected that uses data acquisition. These changes will not be reflected in the data file.

The normal state of the FPG internal valves are set up to put the FPG into gauge mode with the system properly lubricated when power is turned off. This is a safe condition that should occur immediately following a power up. However, improper connections or pressure supplies can prevent this safe condition. As a result, it is good practice to always leave FPG Tools in a run mode when the FPG is set up. This is the only means of determining the conditions of the FPG.

6.5.1 RUN MODE INITIALIZATION

Before FPG Tools can monitor the output of the FPG, the software must be initialized to set the system to a known state. The initialization process must occur one time at the beginning of the transition from an idle state to any run mode. After a run mode is entered, transitions to other run modes do not require another initialization. FPG Tools automatically initializes the system when required. While initialization is in progress, the **<Status Bar>** will display information specific to the current step in the initialization process.



Do not abort operations that take place as part of the initialization process. If the FPG is not properly initialized, pressure will not be calculated.

- ❶ Update the **<Tare Display>** with the last saved tare information for the FPG. FPG pressure is calculated only after valid tare data is available.
- ❷ Initialize the RS232 interface of the FPG. An RS232 cable must be connected to the FPG COM1 port and an RS232 port on the host PC. The host PC port must be specified using the **<System Setup><Interface>** option (see Section 6.6.2.2).
- ❸ Initialize the remote interface of the VLPC if it is enabled in the system configuration (see Section 6.6.2.1). An RS232 cable must connect the FPG COM2 port to the COM1 port of the VLPC. There is no software setup required to specify port and communications settings. When the VLPC is enabled and an interface error occurs, the initialization process is aborted.
- ❹ The current valve state, reference pressure and lubrication pressure are queried to determine the active measurement mode. The mode that most resembles the valve and pressure configuration within the FPG is then specifically set. When the mode is not fully defined by the pressure and valve state, a prompt will occur to select the desired mode to operate on.
- ❺ Initialize the remote interface of the DUT if enabled in the **<Current Configuration>**. The DUT must be connected to the host PC according to the DUT interface selections in the **[Config]**, **[System Setup]**, **<Interface>** option (see Section 6.6.2.2).
- ❻ Initialization is complete.

6.5.2 [RUN MONITOR]

[Run Monitor] automatically refreshes the output of the FPG and allows use of all discrete controls provided by FPG Tools. There are no defined steps in this run mode. Use this run mode to monitor the FPG like a standalone instrument when data acquisition is not necessary. Of the three run modes, **[Run Monitor]** most closely resembles a simple instrument interface. Use the control toolbar and the **<VLPC Interface>** window to set pressure and change the state of the FPG see Sections 6.4.2 and 6.3.6.

6.5.3 [RUN W/POINT LOG]

This option is identical to the **[Run Monitor]** option with the added ability of data acquisition. When the option is selected, a standard file selection dialog displays to allow the entry of the name of the data file. A default data file name is automatically provided by FPG Tools (see Section 9.2.1). Data points can be taken at any time by using the **[Take Point]**, **[Average Point]** or **[Auto Point]** options (see Section 6.6.4.2). There is no time limit or specific sequence required with this option.

All active configuration information available at the time **[Run w/Point Log]** is selected is logged in the header of the data file. Changes made to any parameter logged in the header is not reflected in the completed data file.



For best use of the data file, do not make changes to the program configuration after the run mode begins. Most changes will not be reflected in the data file.

6.5.4 [RUN TEST SEQUENCE]

[Run Test Sequence] is available only after one of the other run modes have been selected. Use this option to execute a test sequence created with the **<Test Sequence Editor>** (see Section 6.6.5). FPG Tools automatically sets each test pressure and averages the results according to the test sequence. When all test cycles are complete, FPG Tools automatically sets **[Run Monitor]** mode and vents all system pressure. For this reason, test sequences are a good way to safely run long, multi cycle tests overnight. The steps involved with running a test sequence are described below.

- ❶ Select the data file name. FPG Tools provides a default data file name that can be edited as desired (see Section 9.2.1).
- ❷ Select the test sequence to execute.
If a pressure cycle is specified in the test sequence, the VLPC is set to a range that best accommodates the pressures in the pressure cycle. The maximum then minimum pressure cycle pressures are set for the number of pressure cycles specified. This pressure cycle occurs only one time, at the beginning of the first test cycle.
- ❸ A VLPC range is selected that allows the maximum test sequence pressure up to the first range change in the test sequence or the end of the test, whichever comes first. The hold and stability limits specified on the **<Control>** tab of the test sequence are set at this point.
- ❹ The test sequence begins stepping through the test points starting with the first test point in the test sequence.
 - ❶ If the test point specifies a range change, FPG Tools detects the best range to use for the test points between the current point and the end of the test, whichever comes first. This optimum range is automatically set if it is not the active range. The default hold limits are used whenever the VLPC pressure range is changed in the middle of the test sequence.
 - ❷ If the test point specifies a tare, the system is automatically tared in the same fashion as the **[Zero System]** toolbar function (see Section 5.2).



An internal calibration will be executed for every point that is zeroed when **<Auto run internal calibration while zeroing>** is enabled (see Section 5.2).

- ❺ The test pressure is automatically set using the VLPC when it is active. Otherwise, a prompt is provided for the operator to manually set the test pressure. In this case, do not press the **<OK>** button until the pressure has been set.
 - ❶ If the test point is a tare check point, the zero condition is set and the tare stability test is used to wait for stability (see Section 5.2.2). The pressure is then averaged for the specified averaging time up to 15s then logs the data point. The test sequence resumes with the next test point, Step ❸.
- ❻ FPG Tools waits for a ready condition or a stability timeout before moving on to the next test step. The stability timeout counts down on the status bar during this process.
- ❼ The test dwell time counts down.
- ❽ FPG Tools averages all data for the specified averaging time. DUT data is also averaged when available. The results are logged in the data file and on the main display.
- ❾ Repeat Steps ❸ to ❽ for each step in the test sequence.
- ❿ Repeat Steps ❹ to ❾ for each test cycle.

6.6 [CONFIG]

All changes to the setup of FPG Tools are managed by the options in the **[Config]** menu. The different types of configuration changes are segregated into the categories: **[Settings]**, **[System Setup]**, **[FPG Calibration Setup]**, **[Internal Limits]**, **[Test Sequence Editor]**, **[DUT Editor]** and **[DUT Definition]**. Access to many of the configuration options can be limited by the **[User Level]** feature. The following sections detail each configuration option.

6.6.1 [SETTINGS]

The **[Settings]** options are always enabled for use regardless of the current run mode or user level. When any run mode with data acquisition is enabled, it is recommended that these settings not be changed to avoid inconsistent results. The state of each parameter is logged in the data file at the beginning of the run mode. Changes in the parameters may have an impact on the data but will not be directly reflected in the data file.

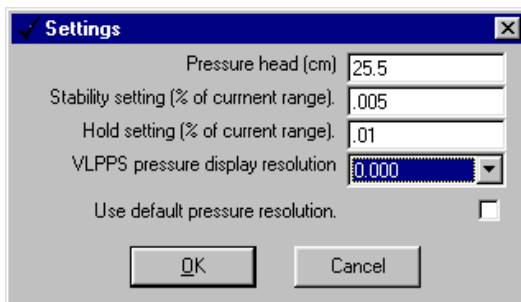

Figure 28. <Settings>

Table 15. System Settings

LABEL	DESCRIPTION
Pressure Head (cm) (entry field)	The height difference in cm from the DUT to the reference level of the FPG. The FPG reference level is slightly above the center of the mounting post (see Section 2.6.1). The convention is to use a negative height value when the DUT is below the reference level and a positive height when the DUT is above the reference level. The calculated head correction is logged for each point when a data acquisition run mode is active.
Stability Setting (%current range) (entry field)	A rate of change of pressure per second limit used to determine a ready condition when automatic VLPC pressure control is not active. If the rate of change of FPG pressure exceeds this limit, the <Ready Indicator> on the <Run Display> is set to red for "Not Ready". The value must be entered as a percentage of the current system range. The range is typically the range of the VLPC when it is active. Otherwise, the range is 10 kPa.
Hold Setting (%current range) (entry field)	A symmetrical positive and negative limit around the target pressure within which the controlled pressure is to be maintained. If the controlled pressure deviates from this limit the <Ready Indicator> is set to red for "Not Ready" (see Section 3.6). The value must be entered as a percentage of the current system range. The range is typically the range of the VLPC when it is active. Otherwise, the range is 10 kPa.
FPG Pressure display resolution (drop down list)	When the <Use default pressure resolution> option is not checked, this field determines the number of digits to display in the FPG (and DUT) pressures. The formatting is applied to the pressure in the currently selected pressure unit. New pressure unit selections will have no bearing on the resolution displayed.
Use default pressure resolution (checkbox)	When this option is checked, FPG Tools uses default display resolution based on the pressure unit selected. User defined units may not display an appropriate amount of pressure resolution (see Section 6.9.1). In this case, uncheck the option and make an appropriate resolution selection.

6.6.2 [SYSTEM SETUP]

This option displays the system setup screen to allow several different types of configuration changes. Click the folder with the label that represents the desired change then make the necessary edits. When all changes are complete, press **<Save>** to activate the changes and return to the main program. Press **<Close>** to ignore the changes and return to the main program.

6.6.2.1 <SETUP>

The **<Setup>** folder defines how FPG Tools will interact with support system devices, what automatic features are enabled and lists program constants that effect overall system metrology. Special care should be taken to ensure that any value entered is in the proper units with the correct sign.

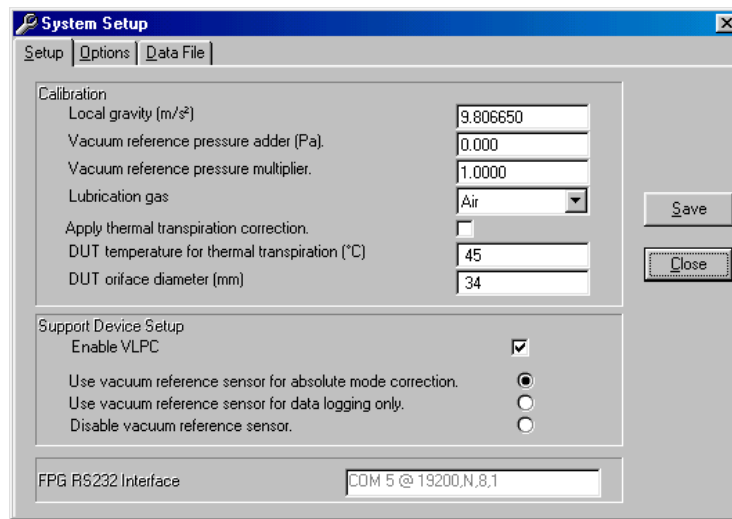



Figure 29. <System Setup><Setup> Tab

Table 16. <System Setup><Setup> Options

LABEL	DESCRIPTION
Local Gravity (entry field)	The gravity determined at the test location of the FPG. This value is used when determining the new calibration coefficient after an internal calibration is performed (see Section 11.3.5.4).
Vacuum Reference Adder (Pa) (entry field)	The pressure adder in Pascal to apply to the output of the vacuum reference device. The value is obtained by pulling vacuum with a turbo pump to achieve a true zero. The output of the device under this condition is the zero offset (see Section 8.3).
Vacuum Reference multiplier (entry field)	The pressure multiplier to apply to the output of the vacuum reference device. The value is obtained by performing a calibration with the device and the FPG.
Lubrication Gas (drop down list)	<p>This is the gas used to lubricate the FPG piston cylinder. Select the gas that will be connected to the "Drive Air" port on the back of the FPG. The gas must be known to properly determine changes in buoyancy on the system.</p> <p>"Air" is the recommended lubrication gas selection. Using Air prevents the need to purge the system prior to use and avoids a gas mixture in the test port of the FPG. If "N2" is selected, the FPG must be thoroughly purged of all traces of Air.</p> <p> Failure to properly purge when N2 is used can result in short term pressure instability and faulty pressure measurements.</p>

LABEL	DESCRIPTION
<p>Apply thermal transpiration correction</p>	<p>Check this box if the DUT requires a thermal transpiration correction. Refer to the DUT instruction manual for details on whether or not the DUT requires a transpiration correction. Thermal transpiration is an absolute pressure measurement mode phenomenon that effects DUTs that are heated significantly above ambient conditions for normal operation. The effect becomes significant at 100 Pa and peaks at approximately 10 Pa. See Section 11.3.4 for details on how the correction is applied. The value of the correction ratio displays real time on the <Run Diagnostics> display.</p>
<p>DUT temperature for thermal transpiration correction</p>	<p>The steady state temperature of a DUT that requires a thermal transpiration correction. This temperature is used to determine the DUTs thermal transpiration correction when the correction is active.</p>
<p>DUT orifice diameter</p>	<p>The minimum connection tube diameter between the DUT and the FPG8601. This value is typically a diameter internal to the DUT.</p>
<p>Enable VLPC (check box)</p>	<p>Check this box to use the VLPC to control the FPG pressure. When checked the <VLPC Interface> display is enabled and available for use. Uncheck this box to use a pressure controller independent of the FPG.</p> <p>This option is automatically checked if a test sequence is selected that uses automatic pressure control and is unchecked if the sequence uses manual control.</p>
<p>Vacuum Reference Options (list box)</p>	<p>This list box allows selection of the three modes of use of the FPG vacuum reference sensor.</p> <hr/> <p> <i>The output of the vacuum reference sensor is not useful in gauge mode because ATM is significantly greater than the full scale value of the sensor. Therefore, all vacuum reference pressure options have no bearing on gauge mode operation.</i></p> <hr/> <p>Use vacuum reference sensor for absolute mode correction - This is the most typical use of the sensor. In absolute mode testing, a vacuum reference pressure device is required to define the absolute pressure from the FPG calculated differential pressure (see Section 2.8). The device output displays in the <Vacuum Reference Prs> field on the <Diagnostics Display> during absolute mode operation.</p> <p>Use vacuum reference sensor for data logging only - The output of the vacuum reference sensor is logged in the FPG data file and displayed on the <Diagnostics Display>. However, the value is not used to convert the FPG differential pressure into an absolute pressure. This is the desired selection for absolute differential mode operation. The vacuum reference pressure can be used for thermal transpiration corrections and determining vacuum stability while testing.</p> <p>Disable vacuum reference sensor - Use this option when no vacuum reference sensor will be used by FPG Tools. "0.0" is logged in the FPG data file and displays on the <Diagnostics Display>. Using this feature in absolute mode induces an error of several Pa depending on the vacuum pump.</p>
<p>FPG RS232 Settings</p>	<p>The COM port and RS232 settings of the FPG. This selection must be selected and saved before FPG Tools can interface with the FPG. By default the FPG will use the RS232 settings 19200, N,8,1. The serial port used to connect the FPG is dependant on the PC used to run FPG Tools.</p>

6.6.2.2 <OPTIONS>

The options tab allows selections related to automatic functions within FPG Tools and the optional DUT manifold.

Table 17 describes the features on this tab.

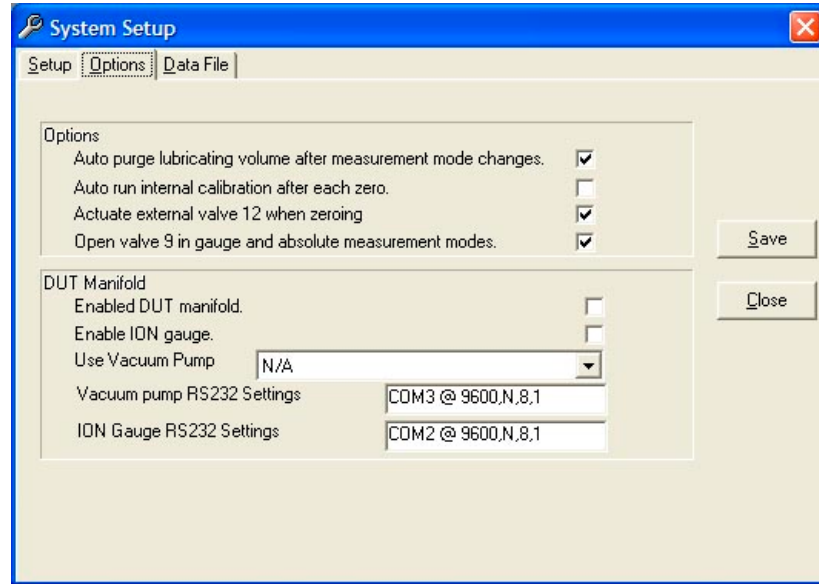



Figure 30. <System Setup><Interface>

Table 17. <System Setup><Options> Options

LABEL	DESCRIPTION
Auto purge lubricating volume after measurement mode changes (check box)	Check this item to automatically run a system purge when the pressure measurement mode is changed. A warm up time and a system purge are typically required after changing measurement modes to rapidly obtain the proper humidity conditions around the load cell. This feature is functionally equivalent to using the <Purge> toolbar function (see Section 6.4.2).
Auto run internal calibration after each zeroing (check box)	Check this feature to automatically run an internal calibration when the FPG is zeroed. This feature should be checked to obtain the best accuracy for the system as it allows for frequent and simultaneous span and zero correction.  <i>An internal calibration must be executed every time the pressure measurement mode is changed. Failure to do so will result in an FPG span error.</i>
Use external valve 12 or zeroing (check box)	Check this box to deactivate external valve driver 12 on the FPG base (see Section 11.1) prior to zeroing and when in gauge mode. The concept of this option is to allow the vacuum reference sensor to remain isolated from atmosphere when it is not in use. Maintaining vacuum is a good way to minimize zero drift.
Enable DUT Manifold	When checked, FPG Tools automatically activates valves related to the FPG manifold as needed when changing measurement modes, zeroing and during other macro processes in FPG Tools. Do not check this option unless the DUT manifold will be used with the FPG.
Enable Manifold Vacuum Pump	Check this option to allow FPG Tools to interface with the manifold vacuum pump. The pump must be powered on and connected to the system PC according to the <Vacuum Pump RS232 Settings>. The pump vent valve and remote switch must be installed on the vacuum pump for proper use. FPG Tools will automatically change the state of the vacuum pump as need by the current operation when the pump is activated. Use the tools on the <DUT Manifold> (see Section 6.3.8) display to manually change the state of the vacuum pump. The Varian 150 Dry Var turbo molecular pump, model 9699163 is the only supported vacuum pump available for this option. Other Varian pumps may also work with the FPG Tools as long as the commands are 100 % compatible.

LABEL	DESCRIPTION
Enable ION Gauge	Check this box to allow FPG Tools to interface with the manifold ion gauge. The ion gauge must be powered on and connected to the system PC according to the <Ion Gauge RS232 Settings> . The ion gauge is used by FPG Tools only when the manifold is zeroed (see Section 5.6). The ion gauge can be controlled manually by using the tools on the <DUT Manifold> display. The Granville Phillips Series 360 Ion Gauge system is the only ion gauge directly supported by FPG Tools.
Vacuum Pump RS232 Settings	Select the RS232 port and settings that the manifold vacuum pump will use. By default, the RS232 settings are 9600, N, 8, 1. The COM port used by the vacuum pump is dependent on the PC used to run FPG Tools.
Ion Gauge RS232 Settings	Select the RS232 port and settings that the ion gauge will use. By default, the RS232 settings are 9600, N, 8, 1. The COM port used by the ion gauge is dependent on the PC used to run FPG Tools.

6.6.2.3 <DATA FILE>

The **<System Setup>**, **<Data File>** tab is used to set user preferences affecting the Data File (*.dat) which records the data from a test run (see Section 9).

The purpose of the **[Data File]** tab fields and settings as well as instructions on how to use them are provided in

Table 18. When selections are complete, click **<OK>** to save changes.

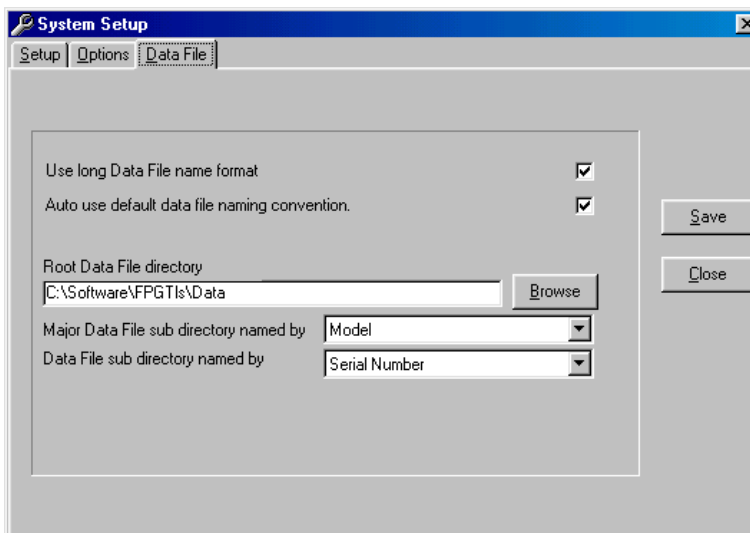

Figure 31. **<System Setup>**, **<Data File>** Tab

Table 18. **<Options>**, **<Data File>** Tab Fields

FEATURE	DESCRIPTION
Use long data file name format (check box)	Check this option to use the long Data File naming convention as described in Section 9.2.1. This feature is checked by default. Although FPG Tools is a 32 bit Windows application, Data Files may be stored on a network or other location that does not support the long file naming convention. To avoid file name truncation, uncheck this option to create default file names that are 8 characters or less.
Auto use default data file naming convention (check box)	When this option is checked, test Data Files are automatically created when [Run w/Point Log] or [Run Test Sequence] is selected. Otherwise, a separate dialog box displays for each active DUT to allow the entry of the data file name. In most cases, automatically naming the data file is desired. However, when some specific tests are executed, it can be more convenient to manually name the data files.

FEATURE	DESCRIPTION
Root Data file directory (text entry field)	Defines the root directory to use when creating new DUT based sub-directories and copying Data Files. The selected directory can be on a network or on an internal hard drive. Any directory selection can be used provided there is enough room to store test Data Files and that the location is not write protected. Use the <Browse> button next to the entry field to select a new or existing directory using a directory browsing tool.
Major Data File sub directory named by & Minor Data File sub directory named by (drop down list box)	FPG Tools generates default file names for Data Files (*.dat) it creates when a test is run. It also creates and uses default directories for the Data Files based on the DUT Definition on which the test was run. These DUT dependent data directories are created as sub directories of the <Root Data File directory> . This feature automatically sorts Data Files in DUT dependent directories so that they can easily be retrieved when desired. The <Major directory...> option determines the name of a sub directory in the <Root Data File directory> . The <Minor directory..> determines the name of a directory to create in the <Major directory...> . The choices are DUT serial number, identification, model, manufacturer or record label. In addition, <None> can be selected. The directory name will include the full text of the DUT Definition field selected unless the <long file name...> option is disabled or DUT information contains one of the following invalid characters as part of the field: /, \, ?, :, *, <, >, , or ". If so, the directory name will contain all text up to the first occurrence of the character.

6.6.3 [FPG CALIBRATION SETUP]

FPG specific calibration information can be selected and entered using this option. Each FPG has it's own unique set of calibration values that must be entered into FPG Tools to accurately determine the final FPG pressure. This is the most critical step in the process of the initial configuration of FPG Tools. Default values in all other aspects of the program setup will not effect the metrology of the system.



Make sure all data is entered in the proper units with the correct sign. Failure to accurately enter FPG calibration information will result in invalid data.

Although most users will have only 1 FPG to set up, FPG Tools supports multiple FPG calibration records. Use the **<Display Selector>** at the top of the screen to view calibration information from other records. To edit a file, click the desired field and make the necessary changes. When all edits are complete either choose **[Save]** to simply store the edits. Or choose **[Save as system selection]** to activate this record for use when the software enters a run mode. The active system selection always displays the **<Record Increment>** in yellow. Use the **[Add]** feature to create a new data record or use the **[Remove]** features to remove the currently selected data record.



FPG Calibration records cannot be modified when FPG Tools is in a run mode. The ability to change and view FPG calibration information is restricted in the standard user level.

The following table summarizes the features of the **<Calibration Setup Screen>**. Refer to the calculation section for more information on the use of these parameters.

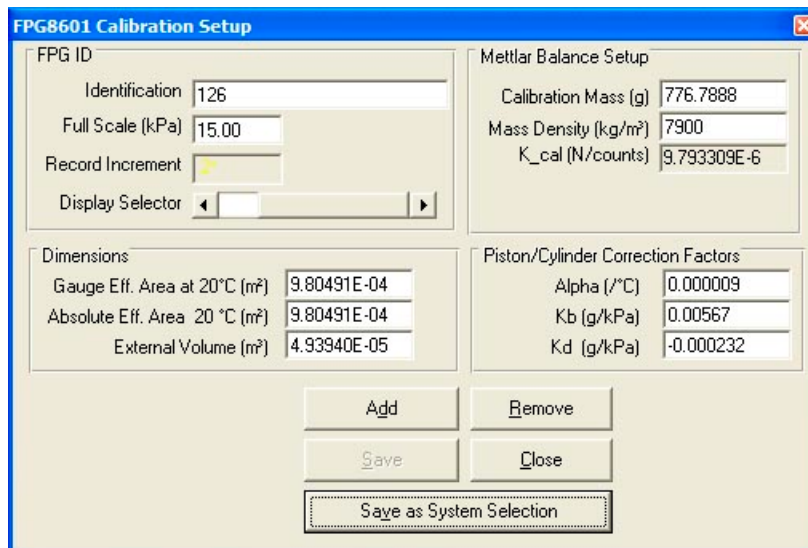

Figure 32. <FPG8601 Calibration Setup>

Table 19. <FPG8601 Calibration Setup> Options

LABEL	DESCRIPTION
Identification (text entry field)	Maximum 50 character length field representing a summary of the FPG calibration file. Any information that easily identifies the unit can be entered into this field. The text entered is logged in the data file.
Record Increment (display label)	Read only field representing the current record increment of the file being viewed. Changing the position of the <Display Selector> automatically updates this value. When the current selection represents the system selection, this field displays in yellow with an asterisk next to the number.
Display Selector (scroll bar)	Use this horizontal scroll bar to view other saved FPG calibration files. Each scroll position corresponds to a specific FPG record increment.
Alpha (/°C) (numeric entry field)	This is the combined temperature expansion coefficient for the FPG piston and cylinder.
Kb (g/kPa) (numeric entry field)	Experimentally determined buoyancy effect due to changes in lubrication pressure.
Kd (g/kPa) (numeric entry field)	Experimentally determined drag effect due to relative changes in lubrication pressure and reference port pressure.
Gauge Area (m²) (numeric entry field)	Experimentally determined effective area of the piston cylinder combination in gauge mode. This value is used by default when the [Internal Limits], <Use area based on measurement mode> (see Section 6.6.4.1) option is not selected.
Absolute Area (m²) (numeric entry field)	Experimentally determined effective area of the piston cylinder combination absolute. Only under special circumstances should this value be different than the <Gauge Area> field. The value entered is used only when the configuration selection <Use area based on measurement mode> option is selected and the FPG is used in absolute measurement mode.
External Volume (m³) (numeric entry field)	The volume of the piston and connecting parts. The parameter is used in buoyancy force calculations.
Calibration Mass (g) (numeric entry field)	True mass value of the internal calibration mass.
Mass Density (kg/m³) (numeric entry field)	Density of the calibration mass.
K_Cal (numeric entry field)	The last saved calibration factor. FPG Tools automatically updates this value when an internal calibration is saved. K_cal is directly multiplied to several other compensation factors to determine the final FPG pressure. Any error in the entry of this value will completely invalidate the calculated pressure. Change this parameter by double clicking the field, then entering the desired value in the input box. The input box displays the default value based on the current local gravity entry, standard density of ATM, and the <Mass Density> parameter. It is recommended that the default calibration factor should be used on all new calibration files. When the file is used for a specific FPG, run the internal calibration manually by using the [Internal Calibration] toolbar function (see Section 6.4.2).

6.6.4 [INTERNAL LIMITS]

The **[Internal Limits]** is provided to change limits and setup information that are typically constant. Changes may be necessary for diagnosing problems or to provide more restrictive limits in an attempt to obtain a better overall uncertainty. Make edits to the desired fields then press the **[Save]** button to accept the changes. Closing the display without pressing **[Save]** ignores all changes.



A thorough understanding of all settings in the [Internal Limits] option is required prior to making changes. Make sure all data is entered in the proper units with the correct sign. Failure to accurately enter limit information can result in the FPG pressure always indicating a not ready condition.

With the exception of the first tab, all tabs in **[Internal Limits]** allow the adjustment of limits specific to a specific type of measurement. In most cases, the limits effect when FPG Tools will provide a re-zero warning and force a “Not Ready” condition. Making a limit too small can make it impossible to be “Ready” and making the limit too large can remove the power of the limit all together. Sound limits are important to ensure that correction values associated with a change in conditions remain small.

6.6.4.1 <SETUP>

The setup tab allows adjustment of diagnostics level setup parameters.

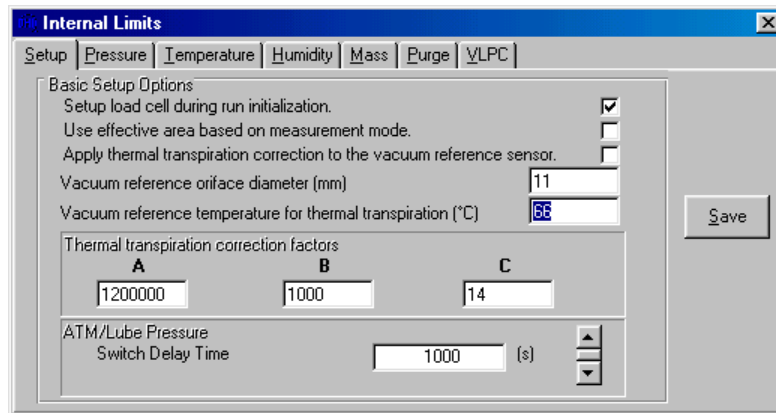

Figure 33. <Internal Limits> <Setup>

Table 20. <Internal Limits> <Setup> Options

LABEL	DESCRIPTION
Setup load cell during initialization (check box)	When checked, FPG Tools re-initializes the load cell's internal parameters as part of the initialization process of any run mode. This option should be checked whenever the load cell parameters were manually modified since the last use of FPG Tools.
Use effective area based on measurement mode (check box)	Check this option to use the effective area setup in the <FPG Calibration Setup> based on the current pressure measurement mode. This option has no effect if the selected calibration file uses the same effective area for absolute and gauge mode (see Section 6.6.3).
Apply thermal transpiration correction to the vacuum reference sensor (check box)	Check this box to apply the thermal transpiration correction to the FPG8601 vacuum reference sensor. By default this value is not checked because the vacuum reference sensor is not calibrated with the thermal transpiration correction active. In general, do not use this feature for normal operation without consulting DH Instruments Technical service.

LABEL	DESCRIPTION
Vacuum reference orifice diameter (mm) (numeric entry field)	The minimum connection tube diameter between the vacuum reference sensor and the FPG8601. This value is typically a diameter internal to the vacuum reference sensor. The value is used only when thermal transpiration is active for the vacuum reference sensor.
Vacuum reference temperature for thermal transpiration correction (numeric entry field)	The steady state temperature of the vacuum reference sensor. The value entered is used to determine the thermal transpiration correction when the correction is active.
Thermal transpiration correction factors (numeric entry field)	Coefficients <A>, and <C> are standard thermal transpiration correction factors (see Section 11.3.4). The values must be specified for the active test gas. Assigning the coefficients for gases other than the test gas will cause significant errors in the determination of the thermal transpiration correction.
ATM/Lube Switch delay time (scroll bar selection)	The time in seconds between atmospheric pressure readings. Use the scroll bar to increase or decrease the switch delay time. Changes in atmosphere (ATM) have a very small yet measurable effect on the FPG. The change in ATM since the last zero results in a small buoyancy force that is quantified by δN_3 (see Section 2.7.3). While ATM is being read FPG Tools is temporarily halted. Therefore, making this time too small can add unnecessary delays to calibrations.

6.6.4.2 <PRESSURE>

All limits related to pressure measurements made by the internal transducer are defined on this tab. Do not confuse these pressure limits with actual FPG calculated pressures. The purpose of each limit is defined on the table below.



When a pressure limit is exceeded an “L” or an “A” will be listed in the <Status> category of the <Diagnostics Display>. This forces a “Not Ready” condition.

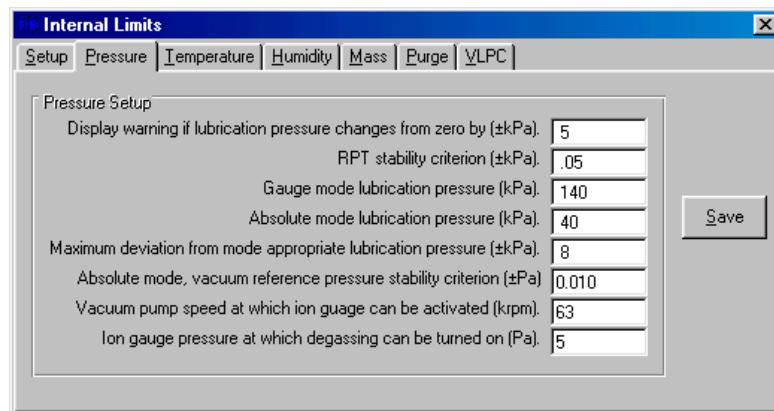

Figure 34. <Internal Limits> <Pressure>

Table 21. <Internal Limits> <Pressure> Options

LABEL	DESCRIPTION
Display warning if lubrication pressure changes from limit by (+/- kPa) (numeric entry field)	Enter a value that represents the maximum deviation of lubrication pressure from its tare value. If the pressure changes by this amount, a warning message will display and an "L" will appear in the <Status> label of the <Diagnostics Display> (see Section 6.3.7). This status code forces a "Not Ready" condition. The value entered should be small to minimize the effect of the $\delta N1$ and $\delta N2$ corrections (see Section 2.7).
RPT stability criterion (numeric entry field)	The maximum acceptable rate of change of pressure for any internal RPT measurement. The criterion effects the limits on lubrication pressure, ATM and reference pressure measurements. When the pressure measurement exceeds the criterion, FPG Tools does not use the new pressure in any calculations but will display the new pressure on the proper run screen. Only stable pressure outputs are used in calculations.
Gauge mode lubrication pressure (numeric entry field)	The optimum lubrication pressure for gauge mode operation. The internal FPG regulators must have been factory adjusted for this pressure. When setting gauge measurement mode, the lubrication pressure must be within the <Maximum deviation from mode appropriate lubrication pressure> value prior to completing the transition.
Absolute mode lubrication pressure (numeric entry field)	The optimum lubrication pressure for absolute mode operation. The internal FPG regulators must have been factory adjusted for this pressure. When setting absolute measurement mode, the lubrication pressure must be within the <Maximum deviation from mode appropriate lubrication pressure> value prior to completing the transition.
Maximum deviation from mode appropriate lubrication pressure (numeric entry field)	When setting gauge or absolute measurement mode, this value represents the maximum deviation from the target lubrication pressure value. If FPG Tools is not able to achieve this pressure, the mode transition will neither complete nor time-out.
Absolute mode, vacuum reference stability criterion (numeric entry field)	In absolute mode when the [Config], [System Setup], <Use vacuum reference sensor for absolute mode correction> option is selected, this entry determines how stable the vacuum reference sensor must be to allow a ready condition. Two consecutive readings (about 1s apart) cannot differ by the value entered, otherwise, a "V" will appear in the status indicator and the FPG pressure will be forced to a "Not Ready" state.
Vacuum pump speed at which the ion gauge can be activated (numeric entry field)	Enter the speed of the turbo pump required to achieve a pressure low enough to safely turn on the ion gauge when zeroing the DUT manifold. Typically, the maximum speed of the turbo pump should be entered. The turbo pump cannot reach maximum speed until the pressure is on the order of 1 Pa.
Ion gauge pressure at which degassing can be turned on (numeric entry field)	Enter the maximum pressure at which the ion gauge's degas option should be turned on. This parameter is used only when the DUT manifold is zeroed and the ion gauge is enabled (see Section 5.6).

6.6.4.3 <TEMPERATURE>

All limits related to temperature measurements made by both of the mounting post PRT's and the temperature sensor located inside the lubricating volume are defined on this tab. Realize that the limits effect both temperature measurements, however, only the mounting post PRT temperature is used in calculations. The purpose of each limit is defined on the table below.



When a temperature limit is exceeded a "T" will be listed in the <Status> category of the <Diagnostics Display>. This forces a "Not Ready" condition.



Both change in temperature and the rate of change of temperature have adverse effects on the load cell. For this reason, always use the FPG in stable laboratory conditions.

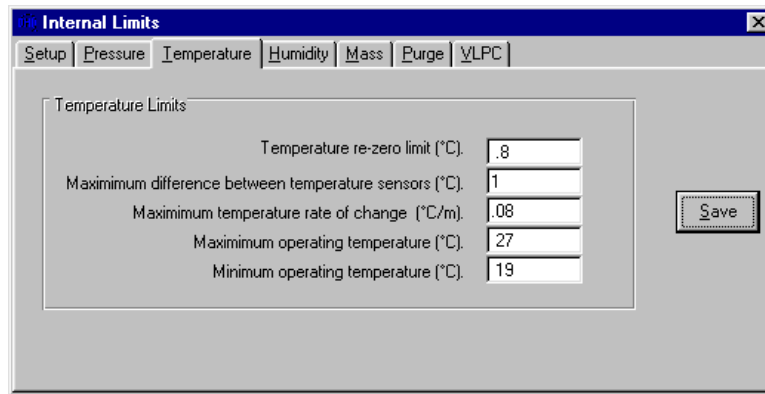



Figure 35. <Internal Limits> <Temperature>

Table 22. <Internal Limits> <Temperature> Options

LABEL	DESCRIPTION
Temperature re-zero limit (°C) (numeric entry field)	The number entered should represent the maximum ± temperature deviation allowed from the tare temperature. When this difference is exceeded, a re-tare target message displays and a “T” will be included in the run screen <Status> output.  <i>Large temperature changes will cause zero drift in the FPG. For this reason, the value entered should never exceed 1.0 °C. Typically .5 °C or less is used.</i>
Maximum difference between temperature sensors (°C) (numeric entry field)	The maximum absolute difference between the mounting post temperature and the lubricating volume temperature. The value is not intended to monitor the calibration offset of the sensors. The goal is to make sure the lubricating volume temperature is not changing relative to the mounting post temperature. If this is the case, the FPG is in unstable temperature conditions and should not be used until temperature stabilizes.
Maximum temperature rate of change (°C/s) (numeric entry field)	Enter the maximum rate of change of either the mounting post or lubricating volume temperature. Large temperature rates of change indicate unstable conditions that will effect the overall stability of the load cell and resulting FPG pressure.
Minimum operating temperature (°C) (numeric entry field)	Enter the minimum temperature value for which the FPG temperature compensation is valid. The FPG is temperature compensated over a temperature range that is centered about 24 °C. Changes in temperature around this range will not effect the FPG as long as the rate of change is small and the FPG is zeroed when temperature changes significantly.
Maximum operating temperature (°C) (numeric entry field)	Enter the maximum temperature value for which the FPG temperature compensation is valid.

6.6.4.4 <HUMIDITY>

All limits related to humidity measurements by the humidity sensor located in the lubricating volume are defined on this tab. Humidity is nominally controlled to 50 % during assembly by adjusting the proper regulators. As long as the bubbling system is filled with water (see Section 8.2) and the FPG is purged when changing measurement modes, the humidity should stay within the required limits. The purpose of each limit is defined in Table 23.



When a humidity limit is exceeded a “H” will be listed in the <Status> category of the <Diagnostics Display>. This forces a “Not Ready” condition.

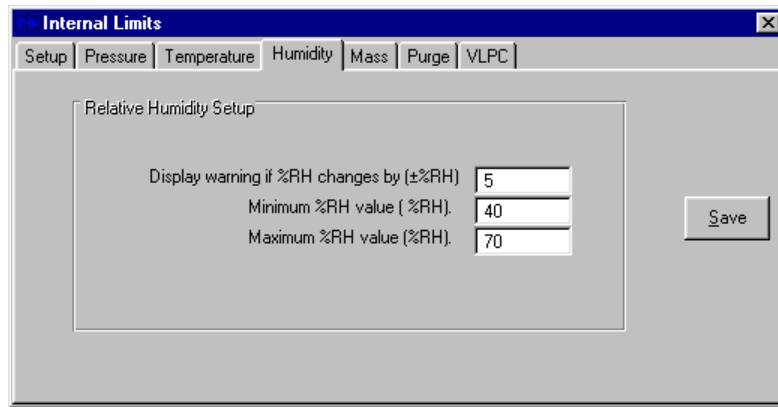

Figure 36. <Internal Limits> <Humidity>

Table 23. <Internal Limits> <Humidity> Options

LABEL	DESCRIPTION
Display a warning if the %RH changes by (numeric entry field)	The maximum change in load cell humidity since the last system tare. Large changes in humidity can be caused by the lack of water in the bubbling system.
Minimum %RH value (numeric entry field)	The minimum operating humidity. Using the FPG when the load cell environment has a humidity less than this value can lead to invalid measurements. The effect of humidity on the load cell dramatically increases when humidity is small, < 40 %. In this condition, a small change in humidity will have a large change on the load cell output. If the minimum humidity cannot be obtained, make sure the bubbling system contains water and that all pressure connections are secure and correct.
Maximum %RH value (numeric entry field)	The maximum operating humidity. Using the FPG under high humidity conditions can lead to unnecessary wear on internal system valves. Typically, purging reduces the humidity within the necessary limits.

6.6.4.5 <MASS>

All limits related to the load cell output are defined on this tab. Specifically, the stability criterion and limits on the internal calibration process. Since the internal calibration process affects the actual slope of the FPG (see Section 5.3), take special care when adjusting these parameters. When an internal calibration is run manually, any limit related failure generates an error message specific to the problem.



Internal calibrations run during automatic test sequences are not activated when any of the internal calibration limits are exceeded. Make sure the limits entered are reasonable for the test conditions.

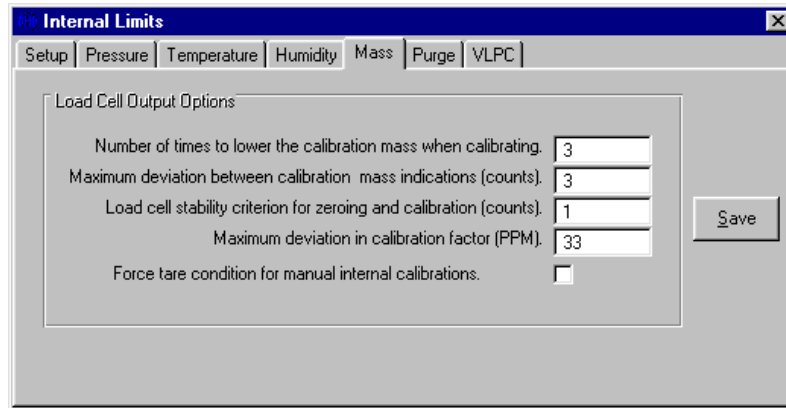

Figure 37. <Internal Limits> <Mass>

Table 24. <Internal Limits> <Mass> Options

LABEL	DESCRIPTION
Number of times to lower the calibration mass when calibrating (numeric entry field)	The internal calibration process lowers and raises the internal calibration mass as many times as specified by this field. The values are averaged together and used in the determination of the calibration factor (see Section 5.3). The number of samples to average becomes important when conditions are somewhat unstable. This is typically the case when the internal calibration will be used when the FPG is at a pressure.
Maximum deviation between calibration mass indications	Enter the maximum acceptable difference between internal calibration mass values when the mass will be lowered multiple times. Use this limit to prevent unacceptable amounts of system noise from biasing the internal calibration results.
Load cell stability criterion for zeroing and calibrations (numeric entry field)	Enter the maximum \pm change in counts allowed during the stability test used prior to zeroing and running internal calibrations. The load cell output cannot change by this amount. Using a value that is too large can allow false stability readings for three consecutive readings.
Maximum deviation in calibration factor (numeric entry field)	The maximum change in the calibration factor between internal calibrations. An error message displays when the calibration factor change exceeds this limit when run manually and internal calibrations ran automatically during tests are not activated.
Force tare condition for manual internal calibrations (check box)	Check this box to cause FPG Tools to vent all FPG pressure and place the system in a tare (zero) condition prior to running the internal calibration. When the value is not checked, the current load cell output is averaged and subtracted from the resultant load cell output when the internal calibration mass is lowered. This allows a user to check the span of the FPG at places other than mid scale.

6.6.4.6 <PURGE>

All limits related to purging are defined on this tab. Purging is an important step in obtaining humidity, pressure and temperature equilibrium in the load cell volume. It is important to properly purge the FPG when changing measurement modes and whenever the lubrication gas is changed. If the lubrication gas is changed, the system should be purged not only by using this function, but by also following the procedure outlined in Section 4.12.1.



This purge is not used to exhaust all gas from the test port of the FPG and any connected DUT. To purge a DUT, set and vent several pressures prior to using the system. A test sequence can be created to purge a DUT (see Section 6.6.5).

Purging consists of opening a valve that exchanges gas in the lubricating volume for a fixed amount of time. The valve is then closed for a fixed amount of time to allow for stability. The change in humidity between the beginning and end of the cycle is used to determine if the purge process should be repeated. Purging is repeated until the humidity criterion is met or the **<Operation Abort>** function is used.

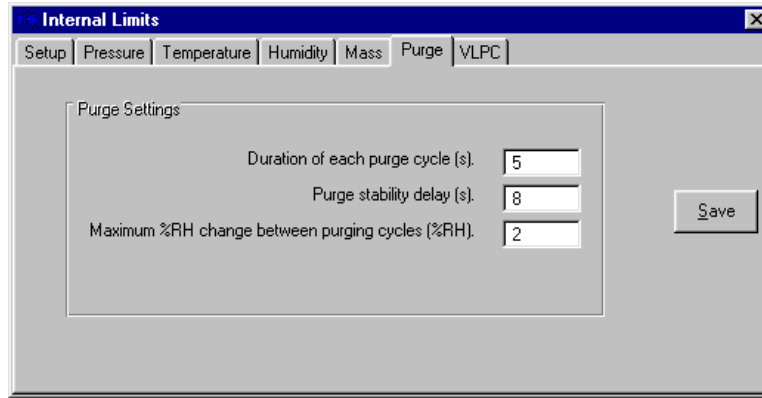

Figure 38. **<Internal Limits> <Purge>**

Table 25. **<Internal Limits> <Purge> Options**

LABEL	DESCRIPTION
Duration of each purge cycle (numeric entry field)	Enter a value that specifies how long gas will be removed from the lubricating volume. In gauge mode, if the limit is sufficiently long, the lubrication pressure will approach ATM. In absolute mode, the lubrication pressure will slowly approach vacuum. Completely removing all gas in the lubricating volume is the goal of purging only when the gas has been changed. Typically, the goal is to obtain a stable humidity value in the proper range. Removing a small amount of gas several times is all that is needed to accomplish this task.
Purge stability delay (numeric entry field)	The time in seconds that FPG Tools should wait prior to comparing the before and after humidity values. If the time is not long enough to allow the FPG regulators to re-fill the volume, the purging process will take longer than necessary or may not obtain proper humidity conditions.
Maximum %RH change between purging cycles (numeric entry field)	Maximum change between the humidity at the beginning of the purge and the humidity after the stability test. If the humidity change exceeds this limit, the purge cycle is repeated. With each successive purge cycle, the change in humidity should decrease because the volume should approach the target equilibrium humidity. Using a value too small for this field will keep the FPG in a continuous purge loop. On the other hand if the value is too large, the volume will not be properly purged.

6.6.4.7 <VLPC>

The minimum and default control limits of the VLPC are defined on this tab. The active control settings used to determine a “Ready” condition are defined by the active test sequence or the current setup in the **<Settings>** (see Section 6.6.1) option. When the hold setting is set too small, the limits setup on this tab determine the actual criterion imposed on the pressure “Ready/Not Ready” indication. Each time a new pressure range is set, the default hold limits specified on this tab are set.

There are separate default values for each gauge and absolute pressure range. The available ranges and the corresponding percent of range hold limits are available only after **[Run]**, **[Run Monitor]** is used and the VLPC is enabled. The available ranges are dependent on the specific setup of the VLPC.

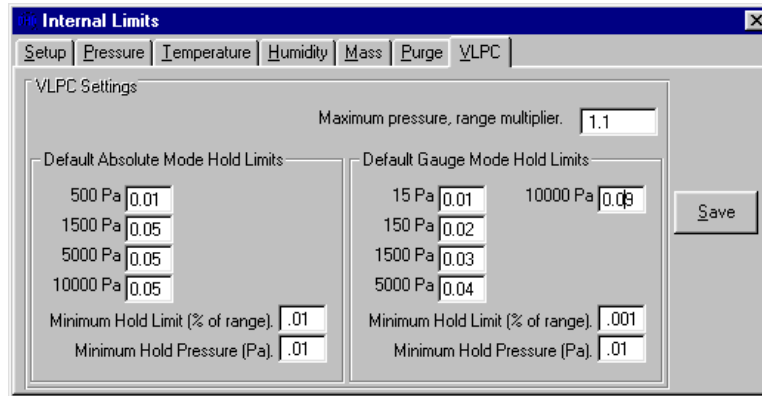



Figure 39. <Internal Limits> <VLPC>

Table 26. <Internal Limits> <VLPC> Options

LABEL	DESCRIPTION
Minimum hold setting (numeric entry field)	The smallest percent of range value that can be used for the hold criterion in the specified pressure measurement mode. FPG Tools generates a warning message if a hold limit smaller than this value is setup in a test sequence or in the <Settings> option.
Minimum pressure for hold criterion (Pa) (numeric entry field)	The minimum pressure that can be used as the hold limit in the specified pressure measurement mode. Attempting to control a pressure below the resolution of the FPG can make it impossible to obtain a “Ready” indication.
Maximum pressure, range multiplier (numeric entry field)	The value entered multiplied by the active VLPC range determines the maximum allowable system pressure. The idea is to protect sensitive DUT’s from overpressurization. In most cases, the value should be 1.1. This allows a 10 % overshoot of the active VLPC range. When the pressure limit is exceeded, VLPPS Tools automatically vents all system pressure and connects the test and reference ports of the VLPPS to remove any differential pressure. Some DUT’s may require a small portion of the active VLPC range. In this case, use a multiplier less than 1 to effectively limit the useable range. <div style="border: 1px solid blue; padding: 5px; margin: 10px 0;">  <i>The VLPC does not significantly overshoot pressure. However, loss of the VLPC valve pressure supply can cause an increase in pressure beyond the range of the VLPC.</i> </div> Without this limit, a DUT would be over pressurized by selecting the wrong test sequence or by accidentally entering the wrong target pressure value.
Default Absolute Mode Hold Limits (numeric entry field)	Each time the VLPC changes to the specified absolute pressure range, the hold limit specified for the selected range is set by default. The hold limit can be changed by using the [Config], [Settings] option.
Default Gauge Mode Hold Limits (numeric entry field)	Each time the VLPC changes to the specified gauge pressure range, the hold limit specified for the selected range is set by default. The hold limit can be changed by using the [Config], [Settings] option.

6.6.5 [DUT SELECTION]

DUTs can be used in FPG Tools by first creating them using the DUT Editor (see Section 6.8). Then by activating them using the **[System Setup], [DUT Selection]** menu choice. Up to 5 DUTs can be activated at any given time with FPG Tools. Select the desired DUT from the list of available DUTs or press the button next to the list to select DUTs by using the DUT selector. Enter a serial number and ID for DUTs that are setup as profiles. Finally, edit the RS232 settings or the IEEE-488 address as required by the current setup. Press the **<Activate DUT(s)>** button to initialize and use the selected DUTs. Remote DUTs are first sent their initialization commands. The output of each DUT is the polled by repeatedly sending each DUT it's set of read commands (see Section 6.8.2.6.5). The output of each DUT displays on the **<Run Display>**. To abort the polling of DUTs, select the **<Deactivate DUT(s)>** menu choice.



A separate data file is created for all active DUTs when any run option is selected that involves the creation of a data file.



Press the backspace key to remove an individual DUT Type.

Figure 40. <DUT Selection & I/O Setup>

Table 27. <DUT Selection & I/O Setup> Options

LABEL	DESCRIPTION
DUT Type (drop down list box)	A list of all DUTs setup using the DUT definition editor (see Section 6.8). Press the button next to the list of DUTs access the DUT selector. Press the <BackSpace> button on the keyboard to remove an individual DUT.
Clear All DUTs (command button)	Clears the entire list of selected DUTs.
Serial Number (conditional text entry)	The serial number specified in the DUT definition appears in this field if the DUT is setup as a definition. If the DUT is a profile, the field will be blank.
Identification (conditional text entry)	The identification specified in the DUT definition appears in this field if the DUT is setup as a definition. If the DUT is a profile, the field will be blank.
Interface Settings (conditional text entry)	Displays the type of interface settings to use for the DUT Definition. Edit this field as required for RS232 and IEEE-488 DUTs.
Activate DUTs (command button)	Press this button to begin polling all remote DUTs.
Deactivate DUTs (command button)	Press this button to stop polling all remote DUTs.
Cancel (command button)	Aborts the DUT selection without saving changes.

6.7 TEST SEQUENCE EDITOR

All Test Sequences are created or edited using the Test Sequences Editor. When editing a test, verify that each editor tab contains the proper information. This will help to avoid conflicts when using the Test Sequence in **[Run Test Sequence]** run mode. Refer to Sections 6.7.1 through 6.7.5 for detailed information on the features and entry fields of the Test Sequences Editor.

The Test Sequence Editor is made up of multiple sections:

- <Toolbar>** (see Section 6.7.1) Includes tools to identify and select Test Sequences and icons to create, save, copy and delete sequences.
- <Points> Table** (see Section 6.7.2) Lists the pressure, range change and tare points included in the test procedure. Test points can be edited in the table or using the auto fill feature under the **<Points>** tab.
- <Points> Tab** (see Section 6.7.3) Provides a short cut method for filling in the pressure **<Points>** table.
- <Sequence> Tab** (see Section 6.7.4) Defines/modifies test point execution aspects including dwell time, averaging time and the number of test cycles.
- <Control> Tab** (see Section 6.7.5) Specifies how pressure will be controlled and what criterion to use when the test is run.

6.7.1 TOOLBAR

All fields above the display tab on the Test Sequence Editor are considered part of the toolbar. The toolbar not only identifies which test is active, but also provides tools to create, delete, save, restore, identify and select tests.

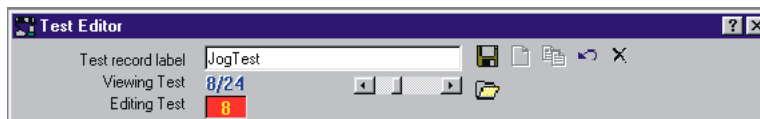







Figure 41. Test Sequence Editor, **<Toolbar>**

Table 28. Test Sequence Editor, **<Toolbar>** Options

FEATURE	DESCRIPTION
Test record label (required text entry field)	This field is analogous to a file name. The text entered should make the test easily distinguishable from other tests. Up to 40 characters can be used in the field. <hr/> <i>Do not use the following characters: \, /, :, *, ?, ", <, >, , a comma or tab character. These characters will cause problems when importing the Data File.</i>
Viewing Test (label)	Identifies the current alphabetical sort position of the test in the editor based on the <Test Record Label> . As the sort order changes, this field also changes. The notation is "Current Test /Total number of tests".
Editing Test (label)	Identifies the sort identification of a test that is being edited. This field does not display when no edits have been made. As the sort order changes, this field also changes.
(toolbar button)	Saves changes to an edited Test Sequence. This field is not available when edits have not been made. Any test conflicts result in error messages when saving. These conflicts must be resolved before saving.
(toolbar button)	Creates a new Test Sequences with default information.

FEATURE	DESCRIPTION
 Copy (toolbar button)	Copies the contents of the current Test Sequence to a new Test Sequence. The <Record Label> of the copied test includes the text "Copy". This is the only difference between the original Test Sequence and the copy. Make sure the new Test Sequence is properly updated before saving.
 Restore (toolbar button)	Restores the Test Sequence to the last saved state. Use this feature to abandon edits made to a Test Sequence before saving. If a new test was created using the <New> option, the restore button is nonfunctional.
 Delete (toolbar button)	Deletes the current Test Sequence. A message prompt for confirmation displays prior to removing the Test Sequence.
 Open/Select (toolbar button)	Displays the Test Sequence Selector loaded with a sorted list of the tests. The selected test will display in the Test Sequence Editor.
 Scroll Select (scroll bar)	Scrolls to the next Test Sequence according to the current alphabetical sort order of the <Test Record Label> .

6.7.2 <POINTS> TABLE

The Test Sequence **<Points>** table is used to define and display the pressure points and FPG tares that make up the test sequence. Pressure, range change and tare points can be added to the sequence by using the **[Insert]** button.





Delete test points from the point sequence by double clicking the point. Click on any tare, or range change image to remove the tare from the test sequence.

Points (mPa)		Insert
1)	20.0	
2)	40.0	
3)	100.0	
4)		
5)		
6)		
7)		
8)		
9)		
10)		
11)		
12)		
13)		
14)		
15)		
16)		
17)		
18)		
19)		
20)		
21)		
22)		

Figure 42. Test Sequence Editor, **<Test Points>** Table

The purpose of the **<Points>** table's fields and settings as well as instructions on how to use them are provided in Table 29.

Table 29. Test Sequence Editor, <Points> Options

FEATURE	DESCRIPTION
<p>Point Type Indication (label)</p>	<p>Indicates how pressure point values in the <Points> table will be interpreted when the test is run. The choices are all available pressure units and <%DUTFS>. If the indication is <%DUTFS>, when the test is run, the pressure points will be calculated from the DUT input span (see Section 6.6.2.3). Specifying points in <%DUTFS> is useful in setting up a common test procedure that runs the same point distribution for DUTs with different ranges. If a DUT is not specified, FPG Tools generates an error when the Test Sequence is selected. To change the point type, use the Test Sequence <Points> tab.</p>
<p>Insert (action button)</p>	<p>Clicking [Insert] causes a pop-up window display with the following insertable options:</p> <hr/> <p> <i>The cursor changes when an [Insert] option is selected. Click the text box of the point that you would like to effect. Clicking any other area aborts the [Insert] function.</i></p> <hr/> <ul style="list-style-type: none"> • Tare Point changes the cursor into a tare icon that can be dropped onto the desired point for a tare of the FPG to occur at that point. A tare icon will appear before the test point. Click the tare icon to remove it. If the Test Sequence <Sequence> tab (see Section 6.7.4) specifies a fixed taring sequence, this selection is disabled. • Insert Point changes the cursor into a pencil icon that can be dropped on any point to insert a blank point at that location. The selected point (and all subsequent points) then shift down, leaving a blank point available for entry. Double click any test point to remove it from the list. • Range Change changes the cursor into a range selection icon that can be dropped on any test point. A range change occurs before the point, so the icon will appear above the selected test point and before the tare icon if present. FPG Tools will only change the VLPC pressure range if a pressure point between the selected point and the next range change (or end of test) requires a pressure that exceeds the current VLPC range or if a VLPC range is better suited for the pressure points. <hr/> <p> <i>When ranges are changed using this option, the default VLPC hold limits are used after each range change instead of the hold limit specified on the <Control> tab.</i></p> <hr/> <ul style="list-style-type: none"> • Tare Check changes the cursor into a tare check icon that can be dropped onto any test point. Tare checks set the FPG to the zero condition (see Section 5.2.1), waits for stability then averages for the specified averaging time up to 15s. The averaged output is logged to the data file like any other test point. The dwell time is ignored. Tare checks are useful when trying to quantify zero drift during a test.
<p>Test Point Table (numeric entry fields)</p>	<p>The test point table lists the test pressure points that will be run in sequential order when the Test Sequence is executed. The values entered are assumed to be in the unit specified by the <Point Type Indication> at the top of the table. If the test points exceed the 22 points that are normally displayed, the scroll bar at the bottom of the table can be used to scroll to additional columns of test points. Up to 100 test points can be included. The test point table can be filled in by placing the cursor in the test point field and editing the desired test point value. It can also be filled in automatically using the <Points> tab. The test point table can be cleared using <Clear> on the <Points> tab.</p>

6.7.3 [POINTS] TAB

The Test Sequence <Points> tab is used to set the <Test Point Type> and provides a short cut to fill in the <Points> table automatically, if desired (see Section 6.7.2).

Figure 43. Test Sequence Editor, <Points> Tab

The purpose of the <Points> tab fields and settings as well as instructions on how to use them are provided in Table 30.

Table 30. Test Sequence Editor, <Points> Tab Fields

FEATURE	DESCRIPTION
Test Point Type (drop down list)	Determines how the pressure point values in the <Points> table will be interpreted when the test is run. Use the drop down list to select the type. The choices are: <%DUTFS> or any supported pressure unit. If the indication is <%DUTFS>, when the test is run, the test points will be calculated from the DUT output span defined in [Config], [DUT Editor] (see Section 6.8). The pressure unit will be defined by the DUT. Specifying points in <%DUTFS> is useful in setting up a common test procedure that runs the same point distribution for DUTs with different ranges. The current point type selection is indicated at the top of the <Points> table (see Section 6.7.2).
Starting Point (numeric entry field)	Defines the first point of an Auto Fill test point sequence. Entering a value in this field has no affect until [Auto Fill] is pressed.
Ending Point (numeric entry field)	Defines the last point of an Auto Fill test point sequence. Entering a value in this field has no affect until [Auto Fill] is pressed.
Step Value (numeric entry field)	Defines the increment used by [Auto Fill] to determine test points between the starting point and ending point. Entering a value in this field has no affect until [Auto Fill] is pressed.
Ascending/ Descending Points (drop down list selection)	Selects whether the [Auto Fill] point sequence will run from the starting point to ending point only or from starting point to ending point and back to starting point. If <Yes> is selected, the test point sequence is from starting point to ending point and back to starting point. The ending point is repeated to provide proper point weighting when calculating best fits from the test data. If this repeated point is not desired, double click the point after the points have been filled in. Making a selection has no affect until [Auto Fill] is pressed.
Auto Fill (action button)	Clicking [Auto Fill] causes the test point table to clear and fills in the table with the points calculated from the auto fill instructions: <Starting Point>, <Ending Point>, <Step Value>, <Ascending/Descending Points>. If the values are such that the distance from starting point to ending point is not an even multiple of the step value, the last step value is adjusted to end exactly on the ending point. Points set up by [Auto Fill] can be edited directly in the <Points> table and new points can be inserted at any point using the <Points> table [Insert] button (see Section 6.7.2).
Clear (action button)	Clicking [Clear] at any time causes all entries in the test point table to clear.

6.7.4 <SEQUENCE> TAB

The Test Sequence <Sequence> tab is used to specify details of how the test points of a test will execute. This includes defining dwell and data reading parameters as well as the number of times to run the test (number of cycles). Note that the order of the fields of the sequence tab follows the order of execution of the different steps of each pressure point when a test is actually run.

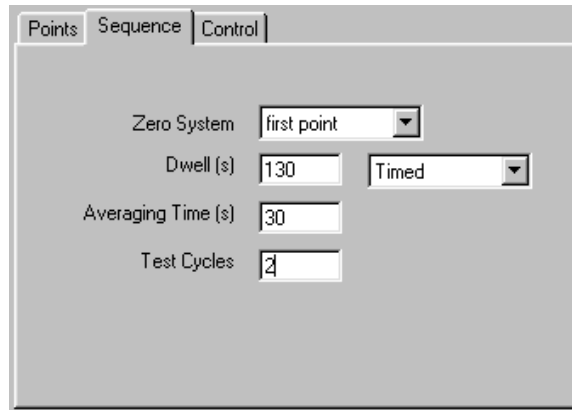

Figure 30. Test Definition Editor, <Sequence> Tab

The purpose of the <Sequence> tab's fields and settings as well as instructions on how to use them are provided in Table 31.

Table 31. Test Sequence Editor, <Sequence> Tab Fields

FEATURE	DESCRIPTION
<p>Zero System (required drop down list selection)</p>	<p>Use the drop down list to select the pressure points at which the FPG should be zeroed. The tare occurs before the test pressure is set. After taring, the target pressure is set and the Test Sequence proceeds with the stability test. There are three (3) choices:</p> <ul style="list-style-type: none"> • Selected points: Uses the tare points manually inserted into the sequence using the <Points> table [Insert] option (see Section 6.7.2). • First point: Automatically adds a tare at the first test point. The <Points> table [Insert Tare Point] option is not active when this choice is selected. • All points: Automatically inserts a tare at every test point in the test point table. When new points are added, they automatically receive a tare when this choice is selected. The <Points> table [Insert Tare Point] option is not active when this choice is selected.
<p>Dwell (required entry field and drop down list selection)</p>	<p>Dwell is a pause that occurs following the stability test, prior to taking averaged test data at each pressure point. When <Dwell> is set to <Timed>, FPG Tools dwells at each test point for the specified <Dwell Time>, 0 – 999s. When <Dwell> is set to <Manual>, FPG Tools dwells at each test point until <OK> is clicked on the <Continue Test> pop-up. This feature can be used to synchronize readings or to pause operation during pressure setting, for example to make adjustments to the DUT.</p>
<p>Averaging Time(s) (required entry field and drop down list selection)</p>	<p>Determines a fixed time over which reference and DUT readings are averaged when taking data at each pressure point. FPG Tools averages for the fixed <Averaging Time> entered, 0-999s. As many readings as possible are taken during the averaging period.</p>
<p>Number of Test Cycles (required entry field)</p>	<p>FPG Tools can run up to 10 test cycles in one test. A test cycle includes setting and taking data at each of the pressure points in the <Points> table. When more than one test cycle is specified. Data from multiple cycles is included in a single Data File (see Section 9.2).</p>

6.7.5 <CONTROL> TAB

The Test Sequence <Control> tab is used to specify how pressure will be controlled for each set point in the test. Pressure can be controlled automatically or manually.



In some cases, using the [Run w/Point Log] feature may allow more flexibility if a combination of pressure controllers including the VLPC will be used.

Figure 44. Test Definition Editor, <Control> Tab

The purpose of the <Control> tab's fields and settings as well as instructions on how to use them are provided in the Table 32.

Table 32. Test Sequence Editor, <Control> Tab Fields

FEATURE	DESCRIPTION
Pressure Control (drop down list)	Determines how pressure will be controlled during the test. The choices are: Manual: Pressure will be set manually by the operator with a device that FPG Tools will not interface with. As a test is run, the operator will be prompted to set the pressure to the target value at each point. Use this choice when the VLPC will not be used to control pressure during the test. When this option is selected, the [System Setup], <Enable VLPC> option is automatically disabled. In this case, the <Stability Setting> will be the determining factor of pressure "Ready/Not Ready". VLPC Automatic: Pressure will be set by the VLPC. The <Hold Limit> will be the determining factor for pressure "Ready/Not Ready" indications at all test points except 0. 0 test points use the <Stability Setting> for their "Ready/Not Ready" indication.
Stability Setting (%VLPC range) (entry field)	A rate of change of pressure per second limit used to determine a ready condition when automatic VLPC pressure control is not active. If the rate of change of FPG pressure exceeds this limit, the <Ready Indicator> is set to red for "Not Ready". The value must be entered as a percentage of the current system range. The range is typically the range of the VLPC when it is active. Otherwise, the range is 15 kPa.
Hold Setting (%VLPC range) entry field)	A symmetrical positive and negative limit around the target pressure within which the controlled pressure is to be maintained. If the controlled pressure deviates from this limit the <Ready Indicator> is set to red for "Not Ready" (see Section 3.6).  When ranges are changed using the [Insert Option], the default VLPC hold limits are used after each range change. The value must be entered as a percentage of the current system range. The range is typically the range of the VLPC when it is active. Otherwise, the range is 10 kPa.
Stability Time-out (required numeric entry field)	The maximum amount of time that the <Stability Test> process may consume. If the stability test has not been satisfied within the <Stability Time-Out>, the Test Sequence automatically proceeds with the <Dwell>. The stability time out is used to assure that a test will not hang indefinitely if the stability test cannot be met at a pressure point. The amount of time required to reach pressure stability is logged in the data file provided that the pressure stabilized before the test averaging began even if the time exceeded the <Stability Time-Out>.

6.7.6 <CYCLE> TAB

Use the **<Cycle>** tab to set up pre-test pressure exercising of the system. The maximum pressure is set followed by the minimum pressure, for the number of cycles chosen. This cycling occurs one time at the beginning of the test regardless of the number of **<Test Cycles>** selected. No data is logged related to the pressure cycle. Cycling pressure is required for good measurement on some DUT's. It can also be used to purge N2 from a DUT prior to starting a test. Fine pressure control is typically not important in this process. Therefore, the hold limit should be relatively large compared to the hold limit used for actual test points. Check the **<Run pressure cycle>** option and fill in the cycle information to run a pressure cycle at the beginning of a test sequence.

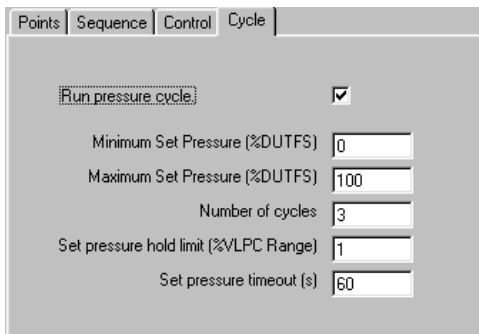

Figure 45. Test Definition Editor, **<Cycle>** Tab

Table 33 describes each of the options on the **<Cycle>** tab.

Table 33. Test Sequence Editor, **<Cycle>** Tab Fields

FEATURE	DESCRIPTION
Run pressure cycle (checkbox)	Check this option to run a pressure cycle at the beginning of a test sequence.
Minimum Set Pressure (numeric entry field)	Enter the minimum cycle pressure in the units specified by the <Test Point Type> field on the <Points> tab. Typically this field should be set to the minimum pressure value of the DUT.
Maximum Set Pressure (numeric entry field)	Enter the maximum cycle pressure in the units specified by the <Test Point Type> field on the <Points> tab. Typically this field should be set to the maximum pressure value of the DUT.
Number of cycles (numeric entry field)	The number of times to set both the minimum and maximum pressures. At least 1 cycle must be specified.
Set pressure hold limit (numeric entry field)	The hold limit as a percentage of the current VLPC range to apply to the minimum and maximum pressure target values during the pressure cycle. When the pressure cycle is complete, the hold limit is set to the value specified on the <Control> tab. Enter 0 to use the default hold limit.
Set pressure timeout (numeric entry field)	The maximum amount of time FPG Tools should allow to set the minimum or maximum pressure cycle pressures. If a ready condition is not met by this time, the next step automatically continues as though the pressure were set properly.

6.8 DUT DEFINITION EDITOR

All DUT Definitions are created or edited using the DUT Definition Editor. When editing a DUT, verify that each Editor tab contains the proper information. This will help to avoid conflicts when using the DUT Definition. Refer to Sections 6.8.1 through 6.8.2.5 for detailed information on the features and entry fields of the DUT Definition Editor.

The DUT Definition Editor is made up of multiple sections:

<Toolbar>	(see Section 6.8.1)	Includes tools to identify and select DUT Definitions and icons to create, save, copy and delete Definitions.
[Header] Tab	(see Section 6.8.2)	Contains general DUT identifying information and the Profile or Individual type choice.
[Correction] Tab	(see Section 6.8.2.2)	Specifies a linear correction to apply to the DUT output.
[Range] Tab	(see Section 6.8.2.3)	Defines the DUT's pressure and measurement output unit and range.
[Tolerance] Tab	(see Section 6.8.2.4)	Specifies the DUT's measurement tolerance type and quantifies the tolerance.
[Read] Tab	(see Section 6.8.2.5)	Defines the DUT's output type and commands to be used.



6.8.1 TOOLBAR





All fields above the tabs on the DUT Definition Editor are considered part of the toolbar. The toolbar not only identifies which Definition is active, but also provides tools to create, delete, save, restore, identify and select DUT Definitions Table 34



Figure 46. DUT Definition Editor, <Toolbar>

Table 34. DUT Definition Editor, <Toolbar> Features

FEATURE	DESCRIPTION
DUT record label (required text entry field)	This field is analogous to a file name. The text entered should make the DUT easily distinguishable from other DUTs. Up to 40 characters can be entered in the label. In some cases it may be useful to set up a single DUT more than one time, for example if the DUT supports multiple gases. In this case, a proper use of this field would be to include the mention of the calibration or process gas as part of the record label.  <i>Do not use the following characters in the DUT record label: \, /, :, *, ?, ", <, >, , a comma or tab character. These characters will cause problems when importing the Data File or creating the Data File directory based on the data directory naming convention selected using the [Config], [System Setup], <Data File> tab (see Section 6.6.2.3).</i>
Viewing DUT (label)	Identifies the current relative sort position of the DUT in the Editor. As the sort order changes, this field also changes (see Section 6.8.2). The notation is "Current DUT/Total number of DUTs".
Editing DUT (label)	Identifies the sort identification of a DUT that is being edited. This field does not display unless a DUT is being edited. As the sort order changes, this field also changes (see Section 6.8.2).
Save  (toolbar button)	Saves changes to an edited DUT Definition. This button is not active when no edits have been made. Any DUT conflicts result in error messages when saving. These conflicts must be resolved before saving can be completed.

FEATURE	DESCRIPTION
<p>New</p>  <p>(toolbar button)</p>	<p>Creates a new DUT Definition with default information.</p>
<p>Copy</p> <p>(toolbar button)</p>	<p>Copies the contents of the current DUT Definition to a new DUT Definition. The <Record Label> of the copied DUT includes the text "Copy". This is the only difference between the original DUT Definition and the copy. Make sure the new DUT is properly edited before saving.</p>
<p>Restore</p>  <p>(toolbar button)</p>	<p>Restores a DUT Definition that is being edited to the last saved state. Use this feature to abandon edits made to a DUT before saving. If a new DUT was created using the <New> option, the restore button is nonfunctional.</p>
<p>Delete</p>  <p>(toolbar button)</p>	<p>Deletes the current DUT Definition. A message prompt for confirmation displays prior to removing the DUT Definition record.</p>
<p>Open/Select</p>  <p>(toolbar button)</p>	<p>Displays the DUT Selector loaded with a sorted list of the DUTs (see Section 6.8.2). The selected DUT will display in the DUT Definition Editor.</p>
<p>Scroll Select</p>  <p>(scroll bar)</p>	<p>Scrolls to the next DUT Definition following the current sort order.</p>

6.8.2 DUT DEFINITION SELECTOR

The DUT Definition Selector can be used to select DUTs while editing a DUT definition, or selecting DUTs to activate (see Section 6.6.5). Click any of the Selector column headers to sort the DUT Definitions low to high by the data in that column. For example, clicking the **<Model>** column header automatically re-sorts the DUTs based on model. If a DUT is being edited, the **<Editing>** ID number will most likely change with each new sort. The resulting order of DUT Definitions in the DUT Selector determines the order used when scrolling through DUT Definitions in the DUT Definition Editor.

Use the search tools on the DUT Definition Selector to locate a DUT when many exist. Use the **<Search by>** list box to determine which column heading will be used for the search. Then enter the **<Search for>** text and press the **[Search]** button. If the DUT is located, it is selected on the display, otherwise, a message displays noting the DUT was not located.

Click, hold and move the separator bar between column headers to expand or contract the column widths. This may be necessary if a DUT field extends beyond the width of the default column display. The difference between individual DUTs and DUT Profiles is evident in the Selector. The former displays serial number and identification information, while the latter does not. Since most frequently the **<Record Label>** is used to select DUTs, the label text of any selected DUT always displays in the **<Record Label>** field at the bottom left of the window. Press **<Select>** to select the current DUT or press **<Cancel>** to return to the DUT Definition Editor.

The DUT Definition Editor has a scroll feature allowing DUTs to be selected by scrolling. The ordering of the scrolled DUTs is determined by the last sort order in the DUT Selector.



An edited DUT Definition displays in blue text in the DUT Selector.

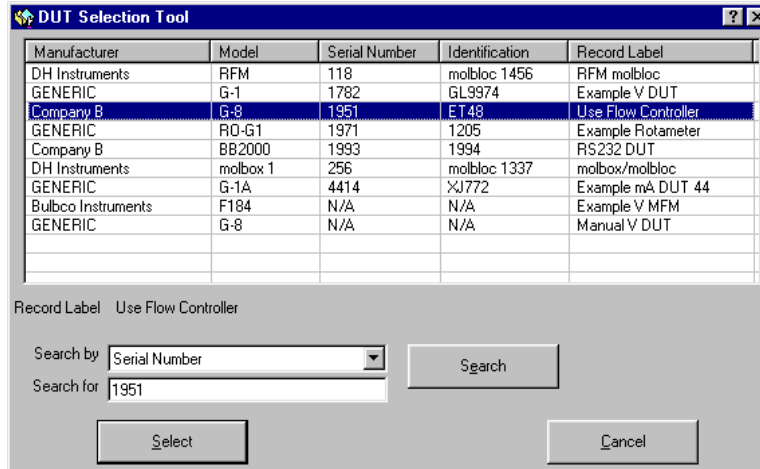

Figure 47. <DUT Selection> Tool

6.8.2.1 [HEADER] TAB

This DUT Definition Editor folder contains common DUT header information. The purpose of the [Header] fields and settings as well as instructions on how to use them are provided in Table 35.



*Do not use the following characters in any of the <Header> fields: \, /, :, *, ?, ", <, >, |, a comma or tab character. These characters will cause problems when importing the Data File or creating the Data File directory based on the data directory naming convention selected using the [Tools], [Options], [Data File] tab (see Section 6.6.2.3).*

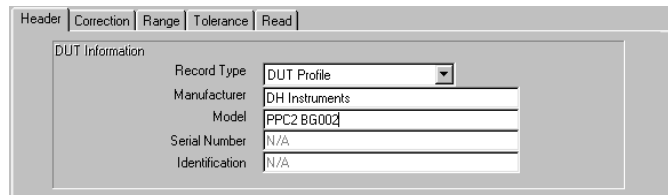

Figure 48. DUT Definition Editor, [Header] Tab

Table 35. DUT Definition Editor, [Header] Tab Fields

FEATURE	DESCRIPTION
Record Type (required drop down list selection)	<p>There are two types of DUT Definitions:</p> <ul style="list-style-type: none"> • Individual DUT Definitions are intended to define a specific, individual DUT. They include a unique DUT serial number and identification value. This type of DUT Definition does not require new entries when being activated. • DUT Profile Definitions are intended to define a general DUT type. They do not include serial number and identification values. DUT profiles are useful when several DUTs of a specific type will be tested. Instead of creating multiple DUTs all differing by serial number and/or identification only, use a DUT profile. This type of DUT Definition requires that the DUT be identified prior to being activated. <p>One definition type must be selected. Default is Individual DUT.</p>
Manufacturer (required drop down list selection)	The DUT manufacturer must be entered in the text box. The field is limited to 40 characters. The default Data File directory naming preference can use this entry to create the directory for Data Files created when this DUT is run (see Section 6.6.2.3).

FEATURE	DESCRIPTION
Model (required drop down list selection)	The model number or name for the DUT can be selected from the drop down list or a new model can be entered manually. The default Data File directory naming preference can use this entry to create the data directory for Date Files created when this DUT is run.
Serial Number (optional text entry field, Individual DUT Definitions only)	Write in the DUT serial number. DUT Profiles do not include a serial number during the creation of the DUT. The default Data File directory naming preference can use this entry to create the data directory for Date Files created when this DUT is run.
Identification (optional text entry field, Individual DUT Definitions only)	Write a DUT identification, if desired. This field can be used for internal tracking of DUTs or to record other information. Any combination of information can be entered into the ID field. The value entered will be included in the test Data Files. The default Data File directory naming preference can use this entry to create the data directory for data files created when this DUT is run. Profile Type DUT Definitions do not include a device ID.

6.8.2.2 [CORRECTION] TAB

The [**Correction**] DUT Definition tab is provided to accommodate DUTs that can use a linear correction applied to their output to achieve a higher accuracy. Enter the adder, multiplier and calibration date in the fields provided. The adder and multiplier are directly applied to the DUT output prior to calculating the DUT pressure. As a result, the adder must be specified in the same units as the DUT output.



The slope and offset values should be determined by using a first order linear regression (best fit). Enter a 1.0 for the <Slope> and 0 for the <Offset> to disable this feature.

Figure 49. DUT Definition Editor, [**Correction**] Tab

Table 36. DUT Definition Editor, [**Correction**] Tab Fields

FEATURE	DESCRIPTION
Slope (Optional numeric entry)	Enter the multiplier to apply to the DUT output prior to calculating the DUT pressure. Enter 1 to effectively disable this feature.
Offset (optional numeric entry)	Enter the offset to apply to the DUT output. The offset must be entered in the output units.
Calibration Date (optional text entry field)	Calibration date associated with the slope and offset entries. This is a text entry, so any date format can be accepted. The value entered is stored in the data file for reference.

6.8.2.3 [RANGE] TAB

The DUT Definition **[Range]** tab is provided to define the relationship between the DUT pressure and raw output. It is assumed that the relationship is linearly proportional in the sense that there is a constant ratio between output and pressure. Select the units that correspond to each parameter using the drop down list provided. If the DUT outputs directly in pressure, select the pressure unit on the **<Pressure Range>** panel, then select the same unit on the **<Output Range>** panel.

Table 37 provides details on each of the **[Range]** tab fields.

Figure 50. DUT Definition Editor, **[Range]** Tab

Table 37. DUT Definition Editor, **[Range]** Tab Fields

FEATURE	DESCRIPTION
Pressure Range Unit (required drop down list selection)	Select the DUT pressure unit of measure from the drop down list. The final calculated DUT pressure is always in the current FPG pressure unit. This unit must be specified to make the unit conversion.
Pressure Range Minimum (required numeric entry field)	Enter the lowest DUT pressure in the pressure range unit of measure. Typically this value is 0. In some special cases, the minimum pressure is non-zero. Regardless, the value entered must correspond to the DUT's <Minimum Output> (see below). This is the expected pressure when the DUT's < Minimum Output> occurs.  <i>All %DUTFS errors are based on the pressure span. Full scale and span are equivalent as long as the <Minimum Pressure> value is zero. If a non zero value is entered, there will be a discrepancy between the actual full scale error and the %DUTFS value determined by FPG Tools. If true full scale error is desired, always enter 0 as the <Minimum Pressure> value.</i>
Pressure Range Maximum Pressure (required numeric entry field)	Enter the maximum DUT pressure in the pressure range unit of measure. This is the expected pressure when the DUT's <Max Output> occurs.
Resolution (required list box selection)	Sets the resolution with which the calculated DUT pressure data will be logged and displayed. Select the desired resolution from the drop down list. This option should be used to adjust the resolution to a level that is appropriate for the performance of the DUT. Typically, resolution is set to one order of magnitude greater than the DUT tolerance. By default, the reference resolution is set to be 1 order of magnitude greater than the resolution selected in this field.
Output Range Units (required drop down list/text entry field)	Select the DUT output unit from the drop down list. If the unit is not on the list, type the unit into the list box. If the output range unit is the pressure range unit, the min/max output fields are automatically set to the min/max pressure range fields. The DUT output must be acquired in this unit for both manual entry and remote DUTs.
Output Range Min Output (required numeric entry field)	Enter the lowest output (output corresponding to the <Minimum Pressure>) of the DUT in the output range unit of measure. If the output unit is the pressure range unit, the <Minimum Pressure> value is copied here and cannot be changed.

FEATURE	DESCRIPTION
Output Range Max Output (required numeric entry field)	Enter the highest output (output corresponding to the <Maximum Pressure>) of the DUT in the output range unit of measure. If the output unit is the pressure range unit, the <Maximum Pressure> value is copied here and cannot be changed.
Output Range Resolution (required drop down list selection)	Sets the resolution with which DUT output (and set) data will be logged and displayed. Select the desired resolution from the drop down list. The pressure resolution is based on the current pressure unit selection (see Section 6.9).

6.8.2.4 [TOLERANCE] TAB

The DUT Definition **[Tolerance]** tab is used to provide a specification for the DUT. The DUT specification is used in calculating DUT errors and in determining if the pressure of a DUT is in or out of tolerance. DUT pressures that are out of tolerance are gray on the **<RUN Display>** run window (see Section 6.3.2). The test status for any point taken when a DUT is out of tolerance will include a “t”. There are several tolerance formatting options. Choose the selection appropriate for the DUT.

Table 38 provides details on each of the **[Tolerance]** tab fields.



%Rdg only tolerances should be avoided if test points at or near 0 will be taken. The tolerance becomes infinitely small as the reference pressure approaches zero. Instead, use a combination tolerance such as <%DUTFS OR %Reading (Greater of)>.

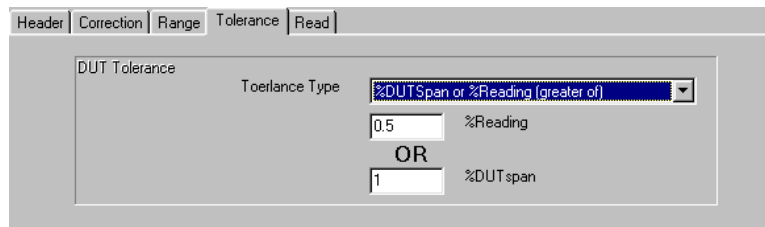

Figure 51. DUT Definition Editor, **[Tolerance]** Tab

Table 38. DUT Definition Editor, [Tolerance] Tab Fields

FEATURE	DESCRIPTION
Tolerance Type (required drop down list selection)	Selects the DUT tolerance formula used to calculate DUT error at test points. Choices are: %DUTFS DUT tolerance is calculated as the pressure span of the DUT times the tolerance value. Span and full scale errors are always the same when the DUT <Minimum Pressure> value is zero. %Reading DUT tolerance is calculated as the current reading of the DUT times the tolerance value. %DUTFS or %DUTreading (greater of) DUT tolerance is calculated at each point as both %DUTFS and %reading. The tolerance used is the greater of the two. %DUTFS + %reading DUT tolerance is calculated at each point as both %DUTFS and %Reading. Tolerance used is the sum of the two. Pressure Unit DUT tolerance is specified as the \pm value of the fixed pressure value entered in the DUT pressure range unit (from the DUT Definition [Range] tab). Output Unit DUT tolerance is specified as the \pm value of the fixed output value entered in the DUT output range unit (from the DUT Definition <Range> tab). None There is no DUT tolerance specification.
Tolerance Value (required numeric entry field)	Specifies the numeric value used to calculate the DUT tolerance. Combination tolerance selections provide two entry fields.

6.8.2.5 [READ] TAB

The DUT Definition [Read] tab defines how FPG Tools acquires data from the DUT. Whatever the data acquisition method, DUT pressure output data must be obtained in the output units specified on the [Range] tab. DUT's that interface directly by RS232 or IEEE-488 require a remote command setup. Manual DUT data acquisition selections require a DUT output entry for each point taken.

Table 39 provides information on the individual [Read] tab fields.

The screenshot shows the 'Read' tab of the DUT Definition Editor. It contains the following fields and controls:

- Mode:** A dropdown menu currently showing 'RS232'.
- RS232 Settings:** A text input field containing '4800,E,7,1'.
- Initialization Commands:** A dropdown menu that is currently empty.
- DAQ Commands:** A dropdown menu currently showing '=>*01P1'.
- Buttons:** A 'Communications Test' button and two 'Edit' buttons (one for Initialization Commands and one for DAQ Commands).

Figure 52. DUT Definition Editor, [Read] Tab

Table 39. DUT Definition Editor, [Read] Tab Fields

FEATURE	DESCRIPTION
<p>Output Type (required drop down list selection)</p>	<p>Specifies what form of data will be acquired from the DUT. The available selections are:</p> <p>RS232 DUT data is gathered directly over the DUT's RS232 interface. The <Initialization Commands> will be issued when the DUT is activated, then the <Read Commands> will be repeatedly sent to obtain real time output from the DUT. The <RS232 Settings> must be selected by clicking the field and making the necessary selections. Information on commands required to read the DUT by RS232 must be provided. This selection is normally used only when the DUT actually outputs directly by RS232. However, it can also be used in a variety of situations in which the DUT does not directly output in RS232 but the device used to read the DUT has an RS232 interface, for example to read DUTs through a conversion module or a multi-meter.</p> <p>IEEE-488 DUT data is gathered using the National Instruments IEEE-488 interface. The <IEEE-488 Address> must be entered before saving the DUT. Information on the commands required to read the DUT by IEEE-488 must be provided. This selection is normally used only when the DUT actually outputs directly by IEEE-488. However, it can also be used in a variety of situations in which the DUT does not directly output in IEEE-488 but the device used to read the DUT has an IEEE-488 interface, for example to read DUTs through a conversion module or a multi-meter.</p> <p>Manual DUT data must be entered manually whenever a point is logged for the DUT.</p>
<p>RS232 Settings/IEEE-488 Address (conditional entry field)</p>	<p>This is the interfacing information for a DUT whose output type is RS232 or IEEE-488. An entry in this field is only required if the <Output Type> in this tab is RS232 or IEEE-488.</p>
<p>Initialization Commands (conditional drop down list/action button)</p>	<p>These are the commands needed to initialize a DUT whose <Output Type> is RS232 or IEEE-488. Click the <Edit> button to display the <Remote Command Editor> (see Section 6.8.2.6). Enter the desired commands then close the form. These commands will be issued when a DUT is activated. If the DUT does not require a specific initialization this field is not used. Refer to the DUT's remote interface manual to determine whether initialization commands are necessary. Possible initialization commands include: setting unit of measure or range. If initialization commands are needed, enter them in the remote command Editor. All commands entered will appear in appropriate list box.</p>
<p>Read Commands (conditional drop down list/action button)</p>	<p>These are the commands needed to read a DUT whose <Output Type> is RS232 or IEEE-488. Click the <Edit> button to display the <Remote Command Editor>. Enter the desired read commands then close the form. These commands are continuously sent to the DUT in all run modes that use the DUT. Up to 10 commands can be issued as part of the reading process, however only one command can be specified as the actual read command. The actual read command is the command that causes the DUT to return its output value. The actual read command is specified by the arrow next to the command, "→". All commands entered will appear in the appropriate list box.</p>
<p>Communications Test (action button)</p>	<p>This feature is used to test communication with a DUT whose <Output Type> is RS232 or IEEE-488. Press this button to send the <Initialization Commands> and <Read Commands> to the DUT. A <Spy Window> will display with the command response information used. This feature is designed to provide on the spot troubleshooting of the remote commands setup. If a command is not properly entered or the response format is not correct, the problem should be visible in the spy window. Use the <Remote Communications> option for further troubleshooting (see Section 6.11.1)).</p>

6.8.2.6 REMOTE COMMAND EDITOR

The remote command editor is used to define commands issued using an RS232 or IEEE-488 interface. The editor changes display options based on the type of command being set up. Some commands require a response while others do not. The remote command editor is connected to the DUT Definition **[Initialization]** and **[Read]** command setups. The editor features are described in the following sections.

6.8.2.6.1 <Leading Characters to Strip>

<Leading characters to strip> applies only to **<Read>** commands. The value entered specifies the number of leading characters to strip from the device response. This is used to allow FPG Tools to properly interpret the output when the response does not start with the output value. This field can include any combination of delimiters and numerical space values.

For example, a device might return the string, "Pressure:4.343 Pa". The actual output value for this example appears at position 9. Therefore, nine leading characters need to be stripped prior to processing the string. Alternatively, if the colon following "Pressure" will always appear prior to the pressure value, ":" could be entered as the leading character to strip. In some cases both a delimiter and a number of characters to strip may be required. For example, if a remote device returns "Range 1, 4.34 volts, NR 4.431 psi", the number of characters in the volts output can change making it impossible to use a fixed length value for the number of spaces to remove to access the pressure value. To avoid this problem enter the text **<,,4>** as the leading characters to strip value. This tells FPG Tools to move to the second comma, then increment four spaces to read the pressure output value.



Only non-numeric text can be used as a delimiter in the leading characters to strip field. All numerical entries are assumed to represent the corresponding numerical value.

6.8.2.6.2 Insert Special Character

Press the **<Ins>** (insert) key to activate the **<Insert Special Character>** option in the event a nonprintable ASCII character is a required part of the remote command. When activated the **<ASCII Characters>** window displays. Select **<Hex>** to select the character using the hexadecimal value or **<Decimal>** to select based on the decimal value. Most non-printable characters will display as a square, printable characters will display as their actual ASCII values. Scroll to the desired character then press the **<Insert>** button. The cursor will turn into a pencil that should be used to point to the location in which the character should be inserted. Move the cursor to the proper position in the command string, then click the mouse button.

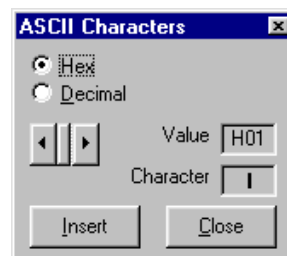

Figure 53. <Insert Special Character> Panel

6.8.2.6.3 <Command Terminator>

Defines how the instrument terminates command strings. The selections available from the drop down list are carriage return, <CR>, and carriage return + line feed, <CR> + <LF>. The majority of instruments that support an RS232 or IEEE-488 interface use carriage return + line feed as the command terminator. Refer to the instrument documentation for details.

6.8.2.6.4 Initialization Commands

Initialization commands are used to set a remote device to a known state. This can include setting a specific unit of measure, range information, gas selection, clearing error buffers, etc. All commands entered are sent just one time when a DUT is activated. Responses to initialization commands are not used in any way by FPG Tools. Therefore, there is no requirement to specify read information.

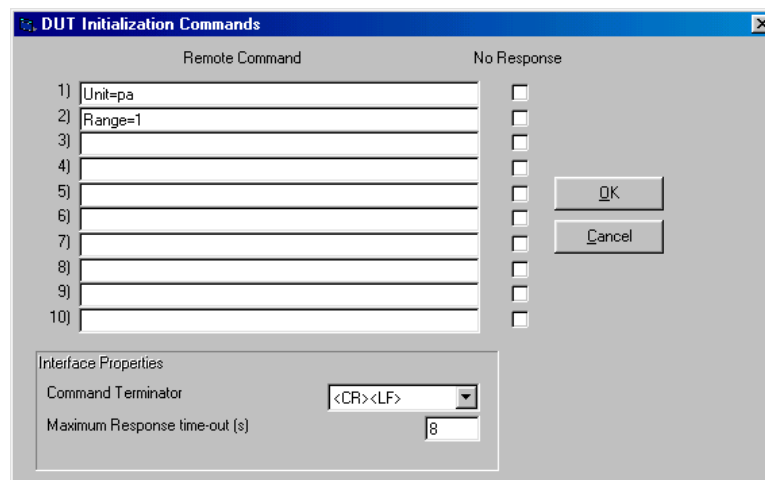

Figure 54. <Initialization Commands Editor> Panel

6.8.2.6.5 Read Commands

Read commands are used to obtain an output from a remote device. When FPG Tools is polling a DUT, the read commands are constantly sent in order to provide real time updating. The faster the instrument responds, the faster the refresh rate on the <Run Display> (see Section 6.3.2). For this reason, it is best to use the smallest number of commands possible to obtain the desired instrument response.

Although, up to ten commands can be issued as part of the read process, one command must be specified as the actual read command. This command, when formatted using the <Leading characters to strip>, should yield an output value in the measurement unit specified for the instrument. Select this command by “dragging” the arrow, “→”, next to it. Each DUT or data acquisition device has it’s own unique set of remote interface commands. Refer to the DUT manual for details on remote commands.

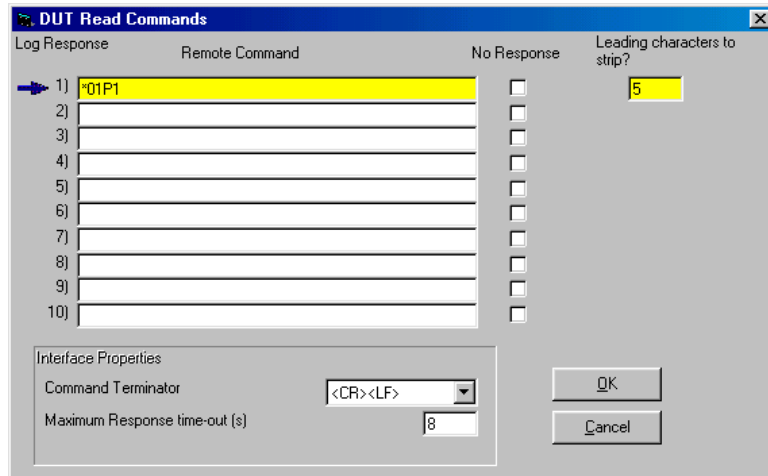

Figure 55. <Read Commands Editor> Panel

6.8.2.6.6 RS232 Interface

RS232 is one of the most widely used interface standards. At least one RS232 port is built into every IBM compatible computer. The interface connects two devices in a full duplex fashion so that both devices can talk simultaneously. The connection requires that the RS232 receive line of one device is connected to the transmit line of the second device and visa versa. In addition to this connection, some devices require the connection of “handshaking” lines to signal the beginning and the interface conversation.

To set up an RS232 instrument, an RS232 cable must be connected between the instrument and the computer. The port on the computer must be specified along with the settings of the remote instrument. The computer RS232 port must be specified and the settings of the port must be adjusted to the settings of the remote instrument. FPG Tools provides setup features to facilitate this step. Refer to the instrument’s manual to determine how to retrieve the RS232 settings.

If the remote interface selection is RS232, the <RS232 Settings> screen must be used to specify the specific setting information. The <RS232 Settings> screen is called up in FPG Tools by clicking any of the RS232 settings displayed. Select the correct settings for the device from the drop down lists and click <OK> when ready. All settings, with the exception of the <COM Port>, are defined by the device that will use the interface. Refer to the instruction manual of that device to determine these settings and make any necessary selections for the interface to function in RS232. The <COM Port> selection should represent the physical connection of the device and an RS232 port on the host computer or the currently configured reference device.



Figure 56. <RS232 Settings> Panel

6.8.2.6.7 IEEE-488 interface

IEEE-488, also known as GPIB (General Purpose Interface Bus), is a popular instrument interface protocol. This interface allows a single IEEE-488 controller card to simultaneously interface with up to 15 instruments. Each instrument must be set to an independent IEEE-488 address from 1 to 30. The controller card also has an address that is used when multiple IEEE-488 cards are installed in the PC. However, this is a rare case.

FPG Tools is designed to function with National Instruments IEEE-488 cards only. Drivers for this card are built into the program. Other cards will not work with FPG Tools even if they work in other software packages.

6.9 [UNITS]

The selection of the FPG display units and measurement mode are made using the **[Units]** menu. A list of standard units are available and up to 10 user defined units can be created and used by FPG Tools. The active pressure unit will have a check next to it in the list. When a new unit is selected, the effect will occur immediately following the next pressure display update. The FPG pressure as well as any DUT pressure will display in the selected unit. FPG Tools automatically converts any DUT's pressure output unit to the selected unit. Pressure data logged in data files is also logged in the selected pressure unit. Conversion factors for each pressure unit are listed in Section 11.2.

6.9.1 [USER DEFINED UNITS]

All user defined units display as a sub menu to the **[User Defined Units]** menu option. Select these units in the same fashion as standard units. When a user defined unit is selected, the unit displays at the bottom of the standard unit list with a check next to it.

Create, edit and delete user defined units by using the **[Manage User Defined Units]** menu choice. When this option is selected, the **<User Defined Units Setup>** form displays. Up to 10 units can be created. Use the scroll bar to select an existing unit for edit, or press the **[New]** toolbar button to create a new unit. Enter a unique **<Unit Label>** that accurately describes the unit. Then enter the unit conversion factor required to convert to the new unit from Pa (Pascal). The entered pressure unit divided by the conversion factor should yield a pressure in Pa. Finally, select a display resolution appropriate for the new unit.



User defined units require a unique name to prevent confusion with other pressure units.

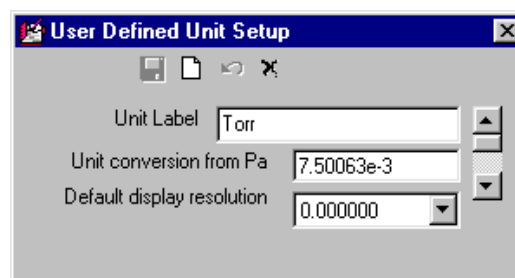

Figure 57. **<User Defined Unit Setup>**

6.9.2 [ABSOLUTE MODE], [GAUGE MODE]

The **[Units]** menu contains selections for measurement mode changes: **[Gauge Mode]** and **[Absolute Mode]**. Prior to selecting either of these modes, make sure all the necessary pneumatic connections are complete. Refer to Section 4.6 for the hardware requirements of changing measurement mode. If the system is properly connected, changing measurement modes simply requires the selection of the **[Gauge Mode]** or **[Absolute Mode]** menu options. There is typically a minimum 30 minute warm up time required to allow total equilibrium of conditions around the load cell when measurement modes are changed.



Prior to changing the current FPG measurement mode, make sure that the FPG, VLPC and the DUT (if connected) are properly connected with all of the necessary plumbing. Refer to Sections 4.6 and 4.10 for information on how to set up the FPG for a specific measurement mode.

If the **<Operation Abort>** option is used during measurement mode changes, it is up to the user to automatically make the necessary valve adjustments to complete the process. FPG Tools does not determine the measurement mode based on the current valve state. The last attempted measurement mode is always used regardless of the valve state.

6.9.2.1 [GAUGE MODE]

Gauge mode operation requires a lubrication pressure of roughly 135 kPa and a reference port pressure equivalent to ATM. FPG Tools automatically adjusts the necessary internal valves to obtain this condition. The specific sequence involved when changing to gauge mode is detailed below.



When changing from absolute to gauge mode, never expose the reference chamber of the FPG to ATM until the lubrication pressure exceeds ATM. Failure to follow this step will reverse the pressure direction of the lubrication gas possibly contaminating the flow pass between the piston and cylinder.

- ❶ Vent all system pressure through the VLPC (if active) and open the system bypass valve.
- ❷ The internal gauge mode valves are adjusted to set the pressure in the lubricating volume.
- ❸ Allow the lubrication pressure to increase to roughly 140 kPa.
- ❹ FPG Tools does not look for any level of system stability when changing measurement modes. The system is now in gauge mode with the system bypass valve open and the VLPC is set to the lowest available gauge pressure range.
- ❺ If the FPG was changed from absolute mode, purge the lubrication volume using the **[Purge]** toolbar function. This step can be included in the automated range change sequence (see Section 6.6.2.1). Allow at least 30 minutes before continuing to the next step.
- ❻ Zero the FPG, then run an internal calibration.

6.9.2.2 [ABSOLUTE MODE]

Refer to Section 4.6 for information on how to set up the FPG for absolute mode operation. FPG Tools handles all of the necessary valving changes to set absolute mode. The specific sequence is defined below.



All required valving and vacuum pumps must be connected prior to attempting to use the absolute mode option.

- ❶ Activate the system vacuum pumps and make sure the mounting post is isolated from ATM.
- ❷ Any VLPC pressure is vented and the bypass valve is opened.
- ❸ The VLPC is set to the lowest available absolute pressure range.
- ❹ The internal transducer is connected to the mounting post to read the reference pressure. The absolute mode process will not continue unless the reference pressure in the mounting post is below 20 kPa.
- ❺ The absolute pressure regulator is then opened. This should reduce the pressure in the lubrication volume to roughly 40 kPa. The internal transducer is pneumatically connected to the lubrication volume to read this pressure.
- ❻ FPG Tools does not look for any level of system stability when changing measurement modes. The system is now in absolute mode.
- ❼ When transitioning from gauge to absolute mode, a minimum 30 minute warm up time should be observed to allow the conditions around the load cell to stabilize.
- ❽ Purge the lubrication volume to reach the proper humidity value. It is possible to always purge after measurement mode changes by using the **[Config], [System Setup], <Auto purge lubrication volume..>** option (see Section 6.6.2.1).
- ❾ Zero the FPG, then run an internal calibration.

6.10 [CHANGE USER LEVEL]

FPG Tools is designed for two basic user levels: Standard and Diagnostic. The standard user level does not allow the features in **[Internal Limits]** and **[FPG Calibration Setup]** to be modified, nor is there access to the **<Valve Control Toolbar>**. This is the intended use of the program. Users will not have the ability to change critical calibration data. The Diagnostics user level provides unrestricted access to all features in FPG Tools. Users can change calibration information as well as manually actuate internal valves. Make sure FPG Tools is operated at a user level appropriate for the user.

To change user levels, abort the current run mode in FPG Tools, then use the **[Config], [Change User Level]** menu option. The user level cannot be changed while the FPG is polled. A dialog appears to allow an 8 digit password to be entered. If you do not wish to use a password, just press **[Enter]**. After a password is entered, it must be used to change user levels. When the appropriate password is entered, FPG Tools completely shuts down and restarts to change to the new user level.



If you do not wish to use a password, just press [Enter]. After a password is entered, it must be used to change user levels. If you forget your password, contact DH Instruments technical service for assistance.

6.11 [TOOLS]

The **[Tools]** menu contains functions useful for trouble shooting. Options in the **[Tools]** menu are not available when FPG Tools is in a run mode. Abort the system monitor to access these options.

6.11.1 [REMOTE COMMUNICATIONS]

The **<Remote Communications>** form is a generic tool used to send commands directly to any instrument using the IEEE 488 or RS232 interface. This tool is provided for trouble shooting purposes to allow commands to be sent directly to the FPG or support instruments. Select the Interface from the interface pull down menu then edit the IEEE 488 or RS232 settings. Type in the command that you wish to send and press **[Enter]** or click **[Send]**. As long as **<Send Only>** is not checked, the reply to the command will appear in the reply box.

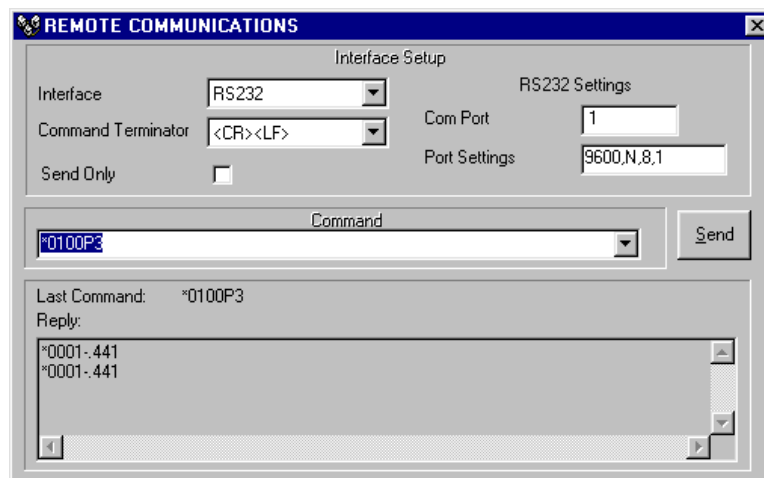

Figure 58. **<Remote Communications>**

6.12 INTERNATIONAL ISSUES

FPG Tools is designed to support the comma and the decimal point as the decimal separator. The **<Decimal Separator>** selected in the Windows **[Control Panel],[Regional Settings]** option determines what decimal separator is used. Make sure that the decimal separator selected is not the same as the **<Digit Grouping Symbol>** or the **<List Separator>** on the **<Regional Settings>** dialogue. There are no options to select in FPG Tools to select the decimal separator. The selection must be made in Windows prior to running FPG Tools. Never change the selected decimal separator when FPG Tools is running. All displays, data files and numeric entries will use the selected decimal separator. Including remote DUTs that may or may not directly output with the current decimal separator. FPG Tools automatically displays the final DUT pressure with the correct decimal separator.

NOTES



7. PISTON-CYLINDER MAINTENANCE

7.1 OVERVIEW



Read this section completely before electing to remove, clean and reinstall the FPG8601 piston-cylinder assembly. Consider restoring piston-cylinder mobility procedures (see Section 7.7) before undertaking piston-cylinder cleaning. In normal operation, the FPG8601 piston-cylinder should operate reliably for many months or indefinitely without the piston-cylinder needing to be cleaned.

The FPG8601 piston-cylinder may have to be removed, cleaned, and reinstalled into the FPG8601. In normal operation, the FPG8601 piston-cylinder will operate for many months or indefinitely without needing to be cleaned. There is no scheduled piston-cylinder cleaning interval, cleaning should only be undertaken when necessary.

Maintenance cleaning may be necessary if the FPG8601 has been back pressured or if the piston is not supplied with lubricating gas pressure for extended periods. Back pressuring occurs when the pressure in the piston-cylinder mounting post exceeds the pressure in the lubricating volume. The most common symptom of a dirty piston is noisy readings when the system is properly lubricated with gas pressure and at zero pressure. See Section 7 for procedures to remove, clean and reinstall the piston-cylinder.

The FPG8601 readings may also become noisy if the piston is no longer well centered in the cylinder. This may occur when installing the piston-cylinder or due to back pressure or lack of lubricating pressure. When this occurs, the piston-cylinder needs to be manipulated to reestablish the gas film between the piston-cylinder that lubricates them so the piston is perfectly mobile. When FPG8601 pressure readings are noisy, unless very obvious signs of contamination are present, always try piston-cylinder manipulation to establish normal behavior before disassembling and cleaning the piston-cylinder. See Section 7.7 for the procedure to reestablish piston mobility.



Failure to follow each of the FPG8601 piston-cylinder disassembly/assembly steps can cause permanent damage to essential parts of the FPG8601.

Table 40. Piston-Cylinder Maintenance Equipment

EQUIPMENT
FPG
FPG piston
FPG cylinder
Glass cleaner
Low lint-free towels/low lint cloth
Low lint gloves
M3 Allen wrench
Compressed air

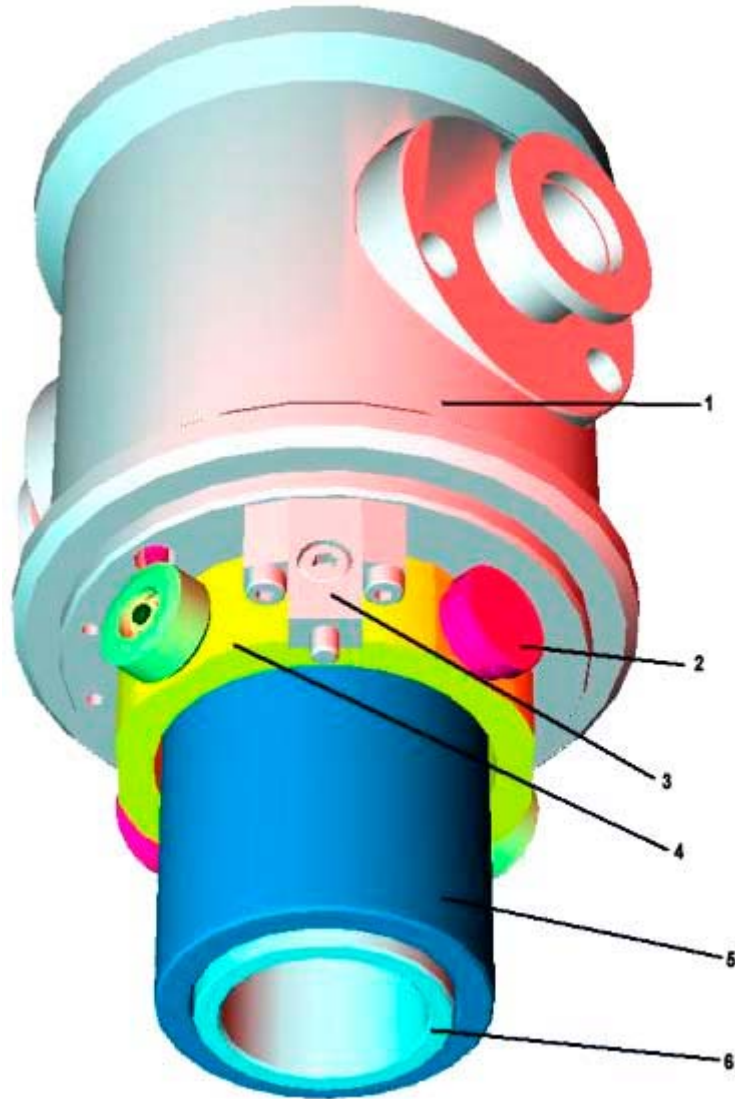

- | | |
|--|----------------|
| 1. Upper mounting post | 4. Gimbal ring |
| 2. Piston retaining nut | 5. Cylinder |
| 3. Indexing block with 3 mm indexing pin | 6. Piston |

Figure 59. FPG8601 Piston Assembly in Mounting Post

7.2 REMOVING THE PISTON-CYLINDER FROM THE MOUNTING POST



Unless the piston-cylinder is obviously contaminated, consider using in situ methods to restore mobility of the piston in the cylinder before removing it and cleaning it (see Section 7.7).

The following procedure describes the steps to be taken in order to safely remove the piston-cylinder from the mounting post. Great care must be taken when removing the assembly. Permanent damage can occur if the recommended steps are not specifically followed.

- ❶ Start with the FPG in gauge mode. If the FPG is in absolute mode, use FPG Tools to transition to gauge mode (see Section 6.9.2.1).

Shut down the FPG system by pressing the **[OFF]** button on the **FPG Run Screen**. Wait until the shut down procedure is complete (FPG Pressure is < --- **SHUTDOWN** --- > and indicates *Ready*).



The FPG reference vacuum CDG is delivered with an isolation valve connected to it. This valve is normally closed and serves to maintain vacuum on the CDG at all times as exposing the CDG to atmospheric pressure will cause zero shifts. Do not break the valve fittings or operate the valve without establishing vacuum first.

- ❷ Remove the vacuum isolation valve (valve 9) on the bottom of the lower mounting post and remove the vacuum reference CDG and valve.
- ❸ Detach the bottom mounting post PRT by unscrewing the knurled nut on the back of the mounting post.
- ❹ Apply a slight upward pressure with one hand under the lower mounting post (see Figure 60).
- ❺ Loosen the nut at the center of mounting post.



The upper and lower mounting post are held together by a large surface area retaining nut that compresses an O-ring between the mounting post halves. Pressing upward on the lower mounting post allows the mounting post nut to be easily unscrewed with one hand. If pressure is not applied to the lower mounting post, the mounting post nut can remove small particles from the mounting post and possibly cause contamination.

- ❻ With the other hand, completely unscrew the mounting post nut.
- ❼ Lower the mounting post down as straight as possible.



If the lower mounting post is not lowered in vertical descent, it will make contact with the external surface of the cylinder. If this happens, contaminants can be introduced into the low-pressure chamber of the mounting post.

- ❽ Fully remove the lower mounting post and set it on a clean surface.



Figure 60. Removing the Mounting Post

- 9 Put on gloves.



NEVER touch the lapped surfaces (polished appearance) of the piston or cylinder with your bare hands. Body oils and acids can permanently etch the surfaces.

- 10 Remove one of the piston retaining nuts.



Figure 61. Removing the Piston

- 11 With one hand supporting the piston to maintain its current position, slowly remove the remaining piston retaining nut.

- 12 Cup the piston-cylinder in your hand, remove the indexing pin (see Figure 61) and allow the piston-cylinder to drop in a straight vertical descent.
- 13 Place the piston-cylinder on a flat surface on several lint-free towels.



When placing the piston-cylinder on the table, make sure to set it down in the vertical position. If the piston-cylinder is set down in a horizontal position, there is a risk of the assembly rolling off the table causing permanent damage.

7.3 REMOVING THE PISTON FROM THE CYLINDER



Never attempt to remove the piston from the cylinder without using the special piston insertion tool and the procedure described in this section. Doing otherwise can result in the piston cocking as it leaves the cylinder and damage to both parts.

As the piston and cylinder are very high precision parts with a gap as small as one micron, a special tool and procedure is required to remove one from the other without risk of the piston cocking in the cylinder and binding as it leaves the cylinder.

When removing the FPG piston from its cylinder, proceed as follows:

- 1 Remove the cup from the spindle of the FPG insertion tool and place both on a flat, stable surface.
- 2 Lift the piston-cylinder by the outside of the cylinder and the inside of the piston. Place the piston-cylinder into the insertion tool.



NEVER touch the lapped surfaces (polished appearance) of the piston or cylinder with your bare hands. Body oils and acids can permanently etch the surfaces.



- 3 Lift the cup and slowly slide it down onto the spindle. The piston is stopped by the ledge at the top of the spindle while the cylinder continues to move down with the cup.
- 4 Using gloves and minimizing contact with the outside polished surface of the piston, remove the piston from the FPG piston insertion tool.
- 5 Slide the cup containing the cylinder up and off the spindle. Remove the cylinder from the cup.



7.4 CLEANING THE PISTON AND CYLINDER

When a piston-cylinder has been shipped, it should usually be cleaned before it is installed in the FPG8601. Cleaning the piston-cylinder may also be necessary to correct noise in FPG8601 pressure measurements cause by poor mobility of the piston due to contamination between the piston and the cylinder.

To clean the piston-cylinder, it must first be removed from the FPG8601 and the piston taken out of the cylinder (see Sections 7.2, 7.3). Once the piston and cylinder is removed and separated, proceed as follows:

- ❶ Place two clean lint-free towels on a flat surface.
- ❷ Place the piston in the horizontal position on the two lint-free towels.
- ❸ Using gloves, fold two other lint-free towels three times over, and mist slightly with Windex® glass cleaner.
- ❹ Gently wipe the piston with the misted, lint-free towels while rolling the piston on the two flat lint-free towels.
- ❺ Make sure to cover all 360 degrees of the piston over its full length.
- ❻ Lay two more clean, lint-free towels on a flat surface.
- ❼ Discard misted lint-free towels.
- ❽ Transfer the piston to the two clean, lint-free towels.
- ❾ Using gloves, fold two new lint-free towels three times over.
- ❿ Buff the piston while rolling it on the flat surface.
- ⓫ Repeat Step ❿ twice.



This step is critical, if any glass cleaner is left on the piston, the piston will not be mobile when it is reassembled and the FPG8601 pressure output will be noisy.

- ⓬ Blow off the piston with very clean forced air.
- ⓭ Fold another lint-free towel three times over, and mist slightly with glass cleaner.
- ⓮ Roll lint-free towel (glass cleaner side out) around two fingers.
- ⓯ Place glass cleaner side of the lint-free towel against the inside surface of the cylinder.
- ⓰ Rotate the cylinder around while wiping the inside surface with an in and out motion.
- ⓱ Repeat on both ends of the cylinder.
- ⓲ Fold another two lint-free towels three times over.
- ⓳ Again, wrap the lint-free towels around two fingers.
- ⓴ Rotate the cylinder around while wiping the surface with an in and out motion.
- ⓵ Repeat Step ⓳ and ⓴ two more times.
- ⓶ Repeat Step ⓳ and ⓴ for both ends of the cylinder.
- ⓷ The cleaning process is complete and the piston can now be put back into the cylinder. The instructions in Section 7.5 must be followed to safely put the piston in the cylinder.

7.5 PUTTING THE PISTON INTO THE CYLINDER



Never attempt to put the piston into the cylinder without using the special piston insertion tool and the procedure described in this section. Doing otherwise can result in the piston cocking in the cylinder and damage to both parts.

When the piston has been removed from the cylinder, it must be put back into the cylinder before the piston-cylinder can be reinstalled in the FPG Platform.



Figure 62. Alignment of the FPG piston in the cylinder



The piston must be installed in the cylinder with the correct end at the top and the correct rotational orientation. Installing the piston incorrectly in the cylinder may result in poor FPG performance and/or out of tolerance measurements.

- ❶ Place the cylinder in the FPG piston insertion tool cup so that the serial number etched on the outside of the cylinder is towards the top and right side up.
- ❷ Slide the cup and cylinder all the way down the insertion tool spindle.



- ③ Using gloves and minimizing contact with the outside polished surface of the piston, carefully place the piston on the top of the piston insertion tool. The serial number etched on the inside of the piston should be towards the top and right side up. The serial number of the piston should be adjacent to the serial number on the cylinder (see Figure 62).



- ④ Slowly lift the cup and cylinder up until the piston enters the cylinder and the cup begins to lift the piston. Lift the cup, piston, and cylinder off of the spindle.



- ⑤ The piston-cylinder is ready to be installed in the FPG platform.

7.6 INSTALLING THE PISTON-CYLINDER IN THE MOUNTING POST

- ① Once the piston has been put into the cylinder, place the silicon O-ring carrier assembly on the upper portion of the cylinder (lip up). The silicon O-ring is orange and more soft than the Viton O-ring, do not confuse the two.
- ② Place the Viton O-ring carrier inside the lower mounting post (lip down). The Viton O-ring is a brownish color and is firm relative to the silicon O-ring.
- ③ Carefully slide the piston-cylinder assembly into the upper mounting post. Make sure that the serial numbers on the piston-cylinder are aligned, and that the marked surfaces are oriented upwards (see Figure 62).
- ④ Align the indexing hole of the cylinder with the hole on the indexing block.
- ⑤ Insert the cylinder retaining screw into the indexing block and the cylinder.
- ⑥ Position the holes on the piston so that they align with the gimbal ring and cylinder holes (where the piston retaining pins will go).
- ⑦ Insert one piston retaining pin and thread it half way in.
- ⑧ Insert the remaining piston retaining pin so that it is tight.
- ⑨ Tighten the first piston retaining pin.

- ⑩ Verify that both retaining pins are tight.
- ⑪ Verify that the silicon O-ring is in place on the upper mounting post (between the upper and lower mounting post).
- ⑫ Attach the lower mounting post, aligning it with the cylinder.
- ⑬ Place a hand under the lower mounting post and firmly press up.
- ⑭ With the other hand, thread the mounting post nut mating the upper mounting post to the lower mounting post.
- ⑮ Restart the FPG by pressing the **[ON]** button on the **FPG Run Screen**. Wait until the start up procedure is complete.
- ⑯ Wait at least five minutes with the FPG at zero gauge pressure. If the pressure (FPG load cell output **<N>**) is noisy, the piston and cylinder may require lubrication restoration procedure (see Section 7.7) or re-cleaning (see Section 7.4).

7.7 RESTORING PISTON-CYLINDER LUBRICATION AND MOBILITY

7.7.1 OVERVIEW

For the FPG piston-cylinder to operate properly, the piston must be well centered in the cylinder so that it is free and mobile. The piston is lubricated and centered by the flow of lubricating gas from the center of the piston-cylinder through its upper and lower conical gaps (see Section 2.2). While the lubricating gas flow can maintain the piston centered in the cylinder, for its action to be effective, the piston must first be well lubricated with gas and centered in the cylinder.

A piston-cylinder that has just been installed in the FPG mounting post may not be well enough centered and lubricated for the lubricating gas flow to center it. The piston centering may also be lost if the lubricating gas flow is interrupted. The symptom of this condition is noisy output of the pressure even when the pressure is stable, in particular when the FPG is being zeroed or when the lower mounting post has been removed.

When the FPG output is noisy it often is not because the piston-cylinder is dirty. It is because it is not well centered and lubricated.

The four procedures described in Section 7.7.2 should be used to center the piston in the cylinder and lubricate it before applying the lubricating pressure.

If the centering methods do not reestablish stability, the piston-cylinder may need to be cleaned (see Section 7.4).

It is not unusual to need to repeat the procedures multiple times.

7.7.2 PISTON CENTERING AND LUBRICATING METHODS

The four procedures below are used to prepare the piston-cylinder for application of the lubrication pressure.

These procedures are used with the piston-cylinder installed in the mounting post but with the lower mounting post removed so that the piston-cylinder can be accessed and manipulated. Remove the lower mounting post following the instruction in Section 7.2, but do not remove the piston-cylinder.

Observe the value of **<N>** on the **FPG Tools Run Display Screen** (see Section 6.3.2). This is the output of the FPG8601 load cell. Alternate the four methods until the output of the load cell is consistently stable ± 1 or 2 counts. Then install the lower mounting post and start the FPG8601 by pressing the **[On]** button on the **FPG Tools Run Display Screen**. The FPG8601 output (display of **<N>**) should increase and then stabilize again ± 1 or 2 counts. If it does not, remove the lower mounting post and repeat the process.

METHOD 1:

CYLINDER MANIPULATION

Hold the cylinder. Gently move it up and down while rotating it. The movement is very limited. Do not force it.



METHOD 2:

LIFT AND DROP

Put a finger under each of the piston retaining nuts. Gently lift the piston compressing the load limiting springs on the piston connecting rods. The movement is very limited. Do not force the piston up. Once the piston is up, let it drop down abruptly.



METHOD 3:

PULL DOWN AND RELEASE

Hold the piston retaining nuts. Gently pull the piston down compressing the load limiting springs on the piston connecting rods. The movement is very limited. Do not force the piston down. Once the piston is down, release it suddenly.



METHOD 4:

STRUM

Place an index finger on the circular bearing on the side of the gimbal ring. Lightly “strum” the bearing to cause a small amount of movement and let the ring return naturally. The movement is very limited. Do not force it.



7.8 DETERMINING EFFECTIVE AREA

There are several ways to determine the effective area of the FPG piston-cylinder. The two most common ways are to cross float with another piston gauge and to compare using a high accuracy null indicator. Since **DHI** determines the effective area of the FPG by cross floating with a PG7000, this section focuses on the cross float procedure with a piston gauge.

For the best results, determine the effective area in gauge mode. There is added uncertainty caused by measuring the residual vacuum of the FPG and a piston gauge in absolute mode. In addition, the testing time is significantly increased due to the time required to achieve a vacuum at each piston gauge mass load. Performing a cross float in absolute mode is still valid and recommended for comparison to gauge mode only.

It is recommended that at least 5 test pressures distributed throughout the 15kPa span of the FPG be used when cross floating the FPG. Each point should be repeated 3 times to make sure that proper leak rate adjustment is achieved.

7.8.1 SETTING UP THE SYSTEM

- ❶ Set up the piston gauge and the FPG for operation in gauge mode. Make sure that the FPG has an isolation valve connected to the test port on the upper left side of the mounting post.
- ❷ Using FPG Tools, create a DUT that is the reference piston gauge and activate it (see Section 5.5). If a **DHI** PG7000 is the reference piston gauge, remote operation is recommended. Use the **[Run w/Point Log]** menu choice to enable data acquisition. It is important that the FPG pressure is averaged at each test point. Select kPa as the pressure unit to simplify the effective area calculations.
- ❸ Obtain a static pressure controller (ex. MPC1) that will allow generation of pressures up to 15kPa.
- ❹ It is important that a common atmospheric reference is used between the piston gauge and the FPG. Connect the atmospheric reference of the piston gauge to the lower mounting post of the FPG. In Figure 63 the PG is connected to the output of valve 9. This connection is used for convenience only. The output of valve 9 is a KF25 fitting so an adaptor is not necessary.
- ❺ Connect a low flow metering valve to the FPG manifold control isolation port as indicated in the diagram. Adjust the metering valve approximately 1/4 turn from fully closed. The valve is used to compensate for the lubrication flow of the FPG at each test pressure. Without the metering valve, the lubrication flow will increase the FPG pressure relative to the piston gauge and cause the piston gauge piston to continually rise.

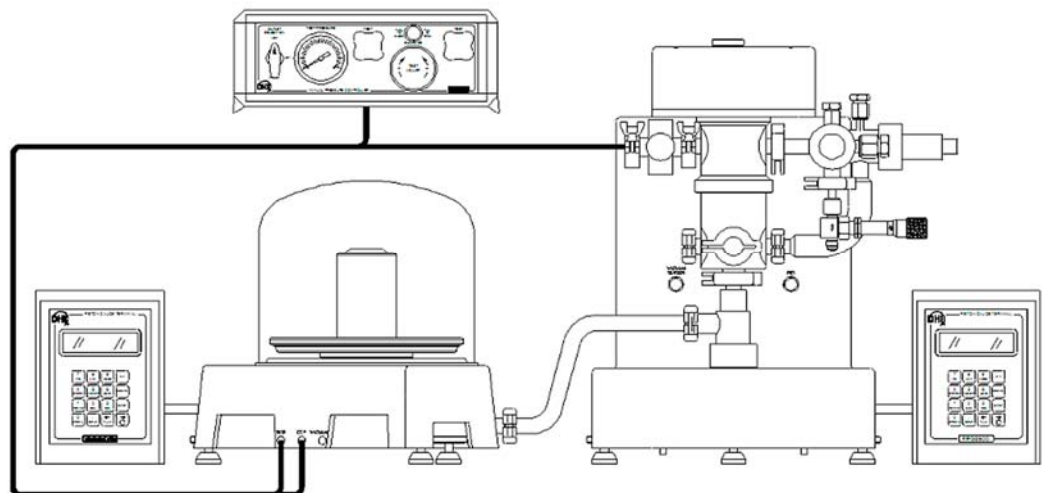

Figure 63. FPG8601 and PG7000 Cross Float Setup

- ⑥ Cap the VLPC connection ports on the FPG manifold. The VLPC is not used in the cross float. It must be isolated to simplify the flow adjustments with the metering valve.
- ⑦ Using several lengths of 1/4 in. PFA tubing, connect the following together.
 - Test outlet on the pressure controller.
 - Test on the back of the PG (and CCP port if Model PG7000).
 - The valve that is on the upper left port of the FPG. Use a 1/4 in. SWG X KF16 adapter for connecting to this port.
- ⑧ When using a PG7000, make sure that the vacuum connection on the back of the unit is open to atmosphere.

7.8.2 GENERATING A PRESSURE

- ① Load the required mass on the piston gauge to set the test pressure.
 - When using a **DHI** PG7000, use only 1.0 kg masses and place the bell jar over the total mass load. The bell jar prevents atmospheric disturbances from affecting the test pressure. The 1.0kg masses have a smaller diameter and limit the parasitic forces caused by air currents generated in the bell jar.



Always limit atmospheric disturbances during the cross float. Opening and closing doors will affect the test. This is especially true when a bell jar is not placed over the piston gauge mass load.

- ② Determine the actual piston gauge pressure as recommended by the manufacturer. When using a PG7000, make sure that the mass set, mass bell and piston-cylinder are selected in the PG Terminal. Then enter the mass load in the terminal to get the fully compensated pressure. If FPG Tools is using the PG7000 remotely,
- ③ Open the isolation valve between the FPG and the PG.
- ④ Close the FPG bypass valve (valve 10) and open the vacuum isolation valve (valve 9) on the FPG.
- ⑤ Open the control isolation valve (valve 11).
- ⑥ Generate a pressure using the pressure controller, floating the piston of the PG.
- ⑦ Once the pressure is achieved, close the isolation valve between the FPG and PG. The FPG pressure and piston gauge pressure should be approximately equal at this point. With the isolation valve closed, the piston gauge should continue to float at the target pressure provided there are no leaks in the system.

7.8.3 ADJUSTING THE NEEDLE VALVE

- ① Adjust the needle valve to cause the rate of change of the FPG pressure, as read by FPG Tools, to oscillate around 0.00mPa/sec. If desired, use strip chart feature in FPG Tools by double clicking the FPG pressure rate on the **<Run Display>**. When the valve is adjusted properly, the pressure rate should be evenly distributed about horizontal plot axis (Y=0).
 - Turn the needle valve clockwise in order to increase the rate of change in pressure and counter clockwise to decrease the rate of change in pressure.
- ② Open the isolation valve between the FPG and piston gauge.
- ③ Re-adjust the pressure controller to float the piston gauge piston, as required.
- ④ Verify that opening and closing the isolation valve does not effect the piston gauge drop rate. If the isolation valve state affects the drop rate of the piston gauge piston, the needle valve must be readjusted. In this case, repeat step 1.



Proper adjustment of the needle valve is required to continue. Improper adjustment will result in apparent non repeatability and lead to an incorrect effective area determination.

7.8.4 TAKING DATA (FOR EACH PRESSURE)

- ❶ Prior to taking data make sure that the piston gauge piston is floating and rotating within the proper limits. Use the automatic rotation keys as required on a PG7000 to rotate the piston and masses.
- ❷ Always take data at approximately the same piston rotation rate. When using a PG7000, a rotation rate of 5 RPM or less is recommended.
- ❸ Use the manual data acquisition average toolbar (see Section 6.4.2) option to average the pressure for the duration of at least 1 piston rotation (15s).
- ❹ Allow the piston gauge piston to stop rotating. Restart the rotation and repeat step ❷ above. At least 3 independent averages should be taken at each test pressure. Zeroing and verifying the internal calibration of the FPG is supported but typically not necessary.

7.8.5 CALCULATING THE EFFECTIVE AREA

- ❶ Determine the difference in pressure between the piston gauge and the FPG (PG-FPG). Convert the difference to mPa.
- ❷ Perform a standard linear regression on the pressure difference [mPa] relative to the FPG pressure [kPa]. Do not force the regression through zero.
- ❸ Take the slope from the regression and apply it to the following formula to determine the correction to the effective area of the piston-cylinder.

$$A_e = A_{test} (1 + 10^{-6} m)$$



The 10^{-6} value is a unit conversion factor used to convert kPa to mPa. If other pressure units are used, make sure that the slope value applied to the effective area is dimensionless. If the difference between the FPG and PG is expressed in kPa and the FPG pressure is expressed in kPa, there is no need for a conversion factor. When mPa and kPa are used, the slope is a PPM value that gives a direct indication of how well the instruments agree.

Table 41. Effective Area Calculation Variables

VARIABLE	DEFINITION
A _e	Calculated effective area m ²
A _{test}	The effective area of the FPG piston in m ² . This value is available in the FPG calibration setup (see Section 6.6.3).
m	Calculated slope determined from the linear regression. When the FPG pressure is in kPa and the pressure difference is in mPa, the value has the unit (mPa/kPa).

Table 42. Sample Effective Area Spread Sheet

FPG PRESS (kPa)	PG PRESS (kPa)	FPG PRES (kPa)	ABS. DIFF. (mPa)	RELATIVE DIFF. (ppm)	RESIDUALS (mPa)	CALCULATED AS LEFT (ppm)
5.0	4.993757	4.993628	- 129	- 26	4	1
5.0	4.993757	4.993638	- 119	- 24	- 6	- 1
5.0	4.993757	4.993619	- 138	- 28	13	3
7.5	7.490637	7.490486	- 151	- 20	- 37	- 5
7.5	7.490636	7.490475	- 161	- 21	- 27	- 4
7.5	7.490637	7.4905	- 137	- 18	- 51	- 7
10.0	9.987499	9.987282	- 217	- 22	- 34	- 3
10.0	9.987499	9.987288	- 211	- 21	- 40	- 4
10.0	9.9875	9.987276	- 224	- 22	- 27	- 3
12.5	12.48438	12.48407	- 310	- 25	- 3	0
12.5	12.48438	12.48408	- 300	- 24	- 13	- 1
12.5	12.48438	12.48407	- 310	- 25	- 3	0
15.0	14.98127	14.9809	- 370	- 25	- 6	0
15.0	14.98127	14.98091	- 360	- 24	- 16	- 1
15.0	14.98127	14.98091	- 360	- 24	- 16	- 1
M (ppm)					-25.085	
B (mPa)					17.400	For reference

Ae used in test [m²]	9.80516E-04
Determined Ae [m²]	9.80491E-04



8. GENERAL MAINTENANCE

8.1 OVERVIEW

The topics in this section describe how to maintain the bubbling system and how to verify and correct the zero of the vacuum reference sensor. The bubbling system is used to humidify the lubrication gas surrounding the load cell. This prevents electro-static effects that can significantly effect system performance. Whenever humidity cannot be obtained even after proper purging, check the bubbling system to make sure there is still water in the system.

The vacuum reference sensor is a high accuracy low range device that is used by the FPG8601 to define an absolute reference pressure, from the natural differential pressure determined from the load cell, piston and cylinder (see Section 2.5). The most significant calibration aspect of this sensor is the change in zero. Since the sensor only measures residual vacuum pressure typically less than 1 Pa (depending on the vacuum pumps used), span error does not significantly impact the overall uncertainty of the FPG. However, any zero offset in the sensor is directly transferred to the zero offset of the FPG. Therefore, it is recommended that the zero of the sensor be checked prior to a series of calibrations in absolute mode. An isolation valve is included with the FPG to minimize zero drift by avoiding the shock associated with the change to atmosphere.

8.2 REFILLING THE BUBBLER ON THE FPG

When the bubbler's water supply is diminished, the humidity of the lubrication pressure will decrease causing instability in the system. This procedure states how to add water to the FPG bubbling system. In this process, the FPG lubricating volume is vented. This will ensure that all gas has been removed from the lubricating volume and the surrounding areas. Once the process is complete, the system will be returned to normal calibrating conditions.

Table 43. Bubbler Maintenance Equipment

EQUIPMENT
FPG
FPG Tools Software
Distilled Water

- 1 Remove the pressure from the FPG by pressing the **[Shut Down]** icon on FPG Tools when the FPG is in gauge mode (see Section 5.9).



It is critical to never tilt the FPG when there is pressure in the system. If this occurs, water from the bubbler will be forced through the lubrication gas lines and into the lubricating volume. This can cause permanent damage to essential parts of the FPG.

- 2 Wait for FPG Tools to display "The FPG is shut down" on the **<Status Bar>**.

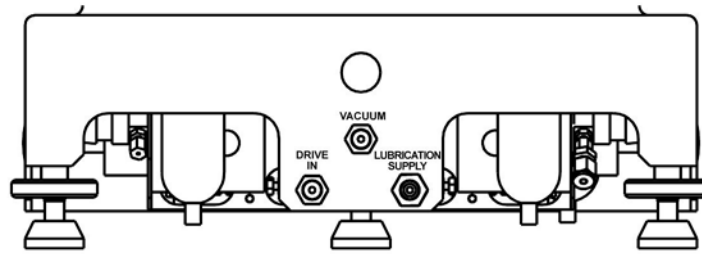

Figure 64. FPG8601 Bubbling System



In Figure 64, the coalescing filter is on the left and the bubbler is on the right. This view is looking at the back of the FPG8601.

- 3 Drain the coalescing filter by placing a lint-free towel under the filter, then pressing the button on the bottom of the filter.
- 4 Remove the bubbler by turning the plastic volume counter-clockwise.
- 5 Fill the bubbler to about 30 % of its capacity with clean distilled water.
- 6 Tighten the bubbler 1/4 turn clockwise after it feels snug against the O-ring.
- 7 Verify that the FPG is level.
- 8 Using FPG Tools, select gauge mode to resume normal operation or press the **[Restart FPG]** icon on the functions toolbar.

8.3 ZEROING THE VACUUM SENSOR

The vacuum reference sensor is used in absolute mode for measuring the reference pressure on the low pressure port of the FPG. This critical device must be re-zeroed at consistent intervals to maintain accuracy in absolute mode. This process describes warm up time, set-up, and testing the zero of the sensor. FPG Tools should be used during this process to view the output of the sensor.



This section describes specific detail related to a Varian Turbo Pump model V70LP. However, any turbo pump capable of achieving a vacuum significantly less 0.001 Pa will work.



The position of the vacuum reference sensor when zeroed should be used in normal operation. Changing the position can have a significant effect on the sensors zero. It is recommended that the sensor be zeroed in the vertical orientation. When zeroed horizontally, the rotation of the sensor also affects the zero. This makes it difficult to mount, remove and remount the sensor without affecting the zero.

Table 44. Vacuum Reference Zeroing Equipment List

EQUIPMENT
FPG
FPG Tools Software
Various KF fittings
Varian turbo pump model V70LP and controller or equivalent
Roughing pump
(Optional) Ion Gauge

8.3.1 SET – UP

This process explains how the fixture needs to be set-up prior to calibration. The entire setup should be on a flat and level surface. Use the **<Diagnostics Display>** on FPG Tools to monitor the output of the vacuum reference sensor.

- ❶ Attach the roughing pump to the exhaust port of the turbo pump.
- ❷ Attach KF40 to KF16 adaptor the to top of the turbo pump.
- ❸ Attach a KF16 elbow or tee to the top of the KF40 to KF16 adaptor.
- ❹ Do not remove the isolation valve from the vacuum reference sensor. Remove the entire valve and sensor assembly from the mounting post of the FPG. The pneumatic connection from the valve to the FPG base is still required to open the valve when zeroing.
- ❺ Attach the open port of the isolation valve (and ion gauge if available) to the side of the elbow or tee in the horizontal position.



If an ion gauge is used while zeroing, never turn on the power of the gauge until the vacuum reference sensor indicates a pressure near vacuum. Most ion gauges are damaged when repeatedly exposed to atmosphere while powered on.

- ❻ Attach the loopback connector to port P1 on the back of the V70 controller.



If the loopback connector is not attached to P1 on the controller, the turbo pump will not activate.

- ❼ Use FPG Tools to monitor the output of the sensor.
- ❽ Make sure that the exhaust valve on the turbo pump is fully closed.
- ❾ Plug in the vacuum pump.
- ❿ Plug in the turbo pump controller.

8.3.2 WARM-UP

The vacuum reference sensor should be connected to the FPG with the power on for 10 continuous hours prior to use. The warm-up time is needed so that the internal heater on the sensor can become stable at 45 °C.

8.3.3 TEST THE ZERO OF THE VACUUM SENSOR

This process allows the zero of the vacuum reference sensor to be verified by pulling it down to vacuum using a turbo pump. The zero is critical in the FPG calculation of absolute pressure. In the instance where the zero is out of specification, the offset must be entered as **[Config], [System Setup], <Vacuum reference sensor offset>** (see Section 6.6.2.1).

- ❶ Make sure that FPG Tools is in factory mode (see Section 6.10).
- ❷ After the 10 hour warm-up time is complete, turn on the roughing pump connected to the turbo pump.
- ❸ Make sure the turbo pump exhaust valve is closed.
- ❹ Allow the vacuum pump to run for a couple minutes.

- 5 Use the **<Diagnostics Display>** in FPG Tools to monitor the output of the sensor. Allow the vacuum pump to pull down the sensor so that a visible change in the output is noticed.
- 6 Press “Start” on the turbo pump controller.



The turbo pump will pump down in stages. Each stage must meet a certain criteria specified by the manufacturer. When the pump completes the final stage a message stating “Normal Operation Reached, 75 kRPM”.

- 7 Actuate valve 12 on the valve control toolbar in FPG Tool (see Section 6.4.3) to expose the sensor to vacuum.
- 8 Continue pumping for at least 8 hours.
- 9 Log the vacuum reference sensor output. The value can be written by hand, or the **[Run], [Run w/Point Log]** option can be used to log the data.
- 10 Once the value is recorded, turn the turbo pump off by pressing “Stop” on the controller. Slightly open the turbo pump exhaust port.



The turbo pump changes audible frequency when going down in speed. Various sounds coming from the turbo pump is normal.

Turn the roughing pump off.

- 11 To correct a zero offset, change the **[Config], [System Setup], <Vacuum reference sensor offset>** (see Section 6.6.2.1) value to the logged offset value but with an opposite sign. If the value is positive, enter a negative number and visa versa. Use the **[Accept]** button to store the changes prior to leaving the **<System Setup>** window.
- 12 Switch to user level (see Section 6.10).

8.4 CALIBRATING THE INTERNAL CALIBRATION MASS

The internal calibration mass is used as a reference for the single point span adjustment performed by the internal calibration process (see Section 5.3). The true mass of the internal calibration mass is compared to the measured mass value to compensate for changes in span. This procedure explains how to remove and replace the internal calibration mass and determine a new true mass value. The active true mass value of the internal calibration mass can be viewed and changed using **[Tools]**, **[FPG Calibration Setup]** (see Section 6.6.3).

Determining the true mass value of the internal calibration mass is similar to any other true mass determination. However, removing the internal calibration mass requires special knowledge of the FPG. Please follow the steps in this section carefully to avoid damaging sensitive FPG components.

Table 45. Vacuum Reference Zeroing Equipment List

EQUIPMENT
FPG Tools Software
M5 allen wrench
M3 allen wrench
Lint-free gloves

8.4.1 INITIAL PREPARATIONS

- ❶ With FPG Tools is in **[Run Monitor]** mode, press the **[Shut Down]** button on the functions toolbar (see section 5.9). Watch the status bar in FPG Tools for an indication that the shutdown process is complete. In this state, the lubricating volume of the FPG is at atmospheric pressure.
- ❷ Press the down arrow icon on the functions toolbar in FPG Tools to lower the internal calibration mass.
- ❸ When the mass is lowered, turn power off on the FPG Terminal. View the counts display on the **<Run Diagnostics>** form for an indication of when the mass is lowered. The counts display should increase by a value equivalent to the mass of the internal calibration mass.

8.4.2 REMOVE THE LOAD CELL COVER

- ❶ Remove the six M6 SHC screws that mount the load cell cover to the load cell plate. All six screws are accessed from the top of the load cell.
- ❷ Facing the FPG, use two hands to grasp the sides of the load cell cover and lift with a slight leftward motion. Lifting in this manner allows for the inside of the load cell cover to be guided away from the load cell. Note that the load cell cover will be sliding up on the internal heat sink that is located within the lubricating volume.



Carefully remove the load cell cover. The load cell can be irreparably damaged if the load cell cover makes contact with the load cell.

- ❸ Set the load cell cover aside on a flat and clean surface.
- ❹ Remove the o-ring between the load cell cover and load cell plate.

8.4.3 REMOVE THE CALIBRATION MASS AND DRIVE

- ❶ Remove the four M4 SHC screws and split washers from the top of the calibration drive.
- ❷ Lift up on the calibration drive just enough so that the mass is above the drive standoffs.
- ❸ Using lint free gloves, slide the mass to the side and then down, out of the drive assembly.
- ❹ Replace the drive assembly on the four standoffs.

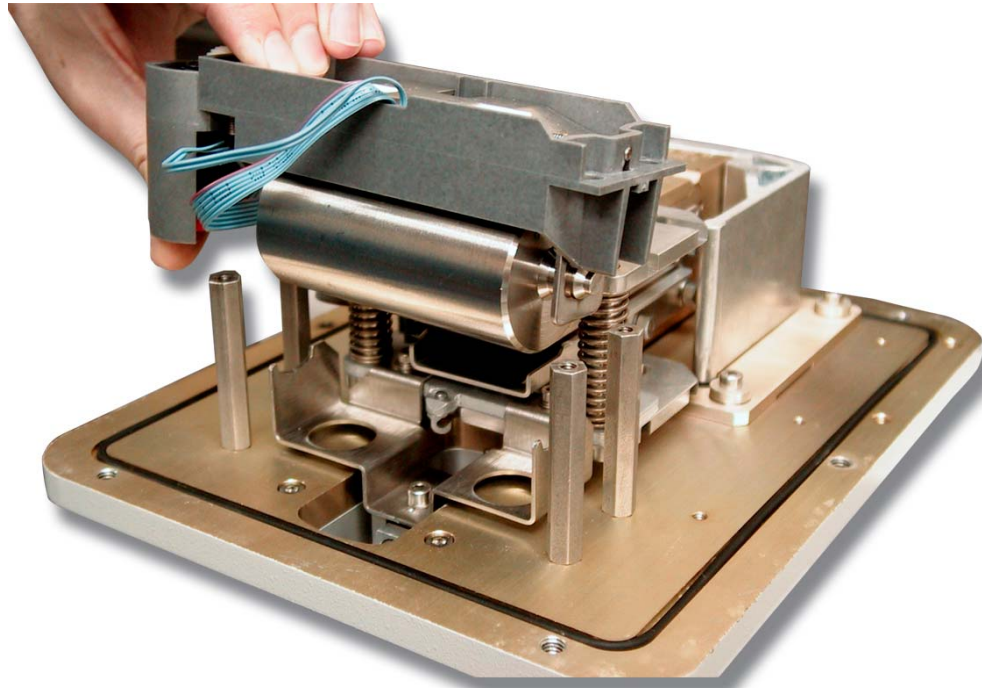

Figure 65. Calibration Mass Drive Assembly



The heat sink is removed in Figure 65 for clarity. It is not necessary to remove the heat sink to perform this procedure.

8.4.4 DETERMINE THE TRUE MASS VALUE OF THE INTERNAL CALIBRATION MASS

The true mass of the internal calibration mass can be determined using any method desired. **DHI** determines the true mass by directly weighing the internal calibration mass on a calibrated balance and adding the buoyancy force to the displayed value. Ambient air pressure temperature and humidity are required to determine the buoyancy force. The equations below describe this process.

$$\rho_{air} = \rho_N \frac{PT_N Z_N}{P_N T Z_{f(P,T)}} + (0.014544 + (-1.0487E - 4 + 1.8969E - 7T)T)H$$

$$m_T = m \left(1 + \frac{\rho_{Air}}{\rho_{mass}} \right)$$

Table 46. Effective Area Calculation Variables

VARIABLE	DEFINITION
ρ_{air}	Calculated density of air.
ρ_N	Nominal density of Air at 0°C, 101.325 kPa and 0 %RH. The value is = 1.2928 kg/m ³ .
P	Measured ambient pressure in Pa.
P_N	Nominal ambient pressure = 101325 Pa.
T	Measured ambient temperature in K.
T_N	Nominal ambient temperature = 273.15°K.
Z	Compressibility of air at the current ambient pressure and temperature. This value can be obtained from the NIST web site.
Z_N	Nominal compressibility of air = 0.99941.
H	Measured percentage of relative humidity.
ρ_{mass}	Density of calibration mass.
M	Indicated mass of the calibration mass. This value is read directly from the scale.
m_T	Calculated true mass of the internal calibration mass.

8.4.5 PUT THE MASS BACK INTO THE DRIVE ASSEMBLY

- ❶ Lift the drive assembly high enough from the standoffs to slide the mass into the assembly.
- ❷ Gently place the mass and drive assembly back onto the standoff. Make sure that the cables going from the drive assembly to the motor and pass through do not obstruct any functions of the mass or load cell. If the cables make contact with the mass, the internal calibration of the load cell will fail or yield faulty results.
- ❸ Attach the drive assembly with the four M4 SHC screws and split washers.

8.4.6 REATTACH THE LOAD CELL COVER

- ❶ Remove the cap from the load cell cover.
- ❷ Form the large o-ring into the O-ring groove of the load cell plate. Note that sometimes the o-ring will come out of the groove. Be careful not to tighten the load cell cover until you are certain that all of the O-ring is within the groove.
- ❸ Hold the load cell cover on its sides so that the bubble level is towards you. Gently slide the back right internal wall of the load cell cover on the external wall of the heat sink.
- ❹ Once the load cell cover is almost down, ensure that the post extending upward from the load cell is aligned with the load cell cap.
- ❺ Secure the load cell cover using the six M6 SHC screws.

8.4.7 FINAL STEPS

- ❶ Turn on the FPG terminal. The calibration drive assembly will automatically raise the mass. FPG Tools will re-establish communications with the FPG within 30s after the power is turned on. If this does not happen, make sure that the RS232 cable is properly connected to the FPG and PC. If communications still does not re-establish, remove the load cell cover and make sure that the internal calibration mass is properly mounted and that there are no cables interfering with the load cell or internal calibration mass assembly.
- ❷ In FPG Tools select the **[Config],[FPG Calibration Setup]** menu choice. On the **<FPG Calibration Setup>** form, enter the new true mass value in the **<Calibration Mass>** field. Click the **[Save]** button to activate the change.
- ❸ Run a new internal calibration prior to running any calibrations with the FPG.

8.5 MOUNTING POST PRT CALIBRATION

The temperature as read by the mounting post PRTs is used to determine the thermal expansion of the piston-cylinder effective area. The temperature is also used to monitor temperature rate of change and temperature change from the time of zero. Accuracy of these PRTs is critical to proper FPG operation. This section describes how to remove and calibrate these sensors.



The temperature sensor inside the lubricating volume of the FPG is used only for an indication of temperature change. The value is not used for FPG pressure determination. Therefore, this sensor is not directly calibrated.

8.5.1 REMOVE THE PRTs

- ❶ Make sure that the FPG is vented in gauge mode. Then turn the power off.
- ❷ Detach the PRT cable from the FPG platform by unscrewing the connection in a counter clockwise direction.
- ❸ Remove each PRT from the mounting post by unscrewing the knurled nut from each mounting post. Note that there are two o-rings that hold each PRT into the mounting post. Remove and save these o-rings.
- ❹ Remove the knurled nut from each PRT.

8.5.2 CREATE THE PRT CABLE ADAPTER

Refer to Figure 66 to create an adaptor cable to calibrate the PRT.

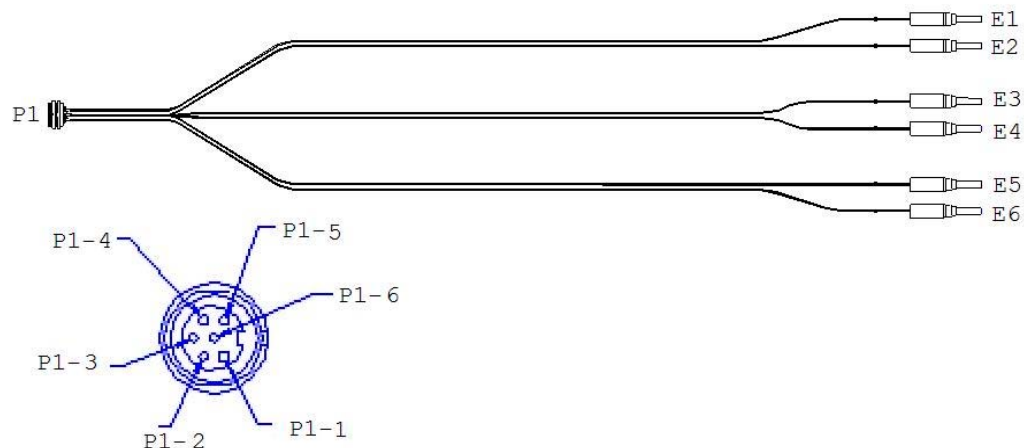

Figure 66. PRT Calibration Cable Adaptor

Table 47. PRT Calibration Cable Connections

FROM	TO	SIGNAL
P1-1	E1	I Source
P1-2	E3	Upper (,1) +
P1-3	E4	Upper (,1) -
P1-4	E2	I Ret
P1-5	E5	Lower (,2) +
P1-6	E6	Lower (,2) -

8.5.3 DETERMINE THE R0 VALUE

R0 is the PRT zero temperature resistance. A separate value must be determined for each mounting post PRT. R0 is determined by converting the reference temperature to a resistance and correcting the 4-Wire resistance of the mounting post PRT. For best results, use the lab temperature in which the FPG will be used. The resistance of the PRT is adjusted based on the temperature reference value as described in the equation below.



The FPG8601 PRTs use a slope of 0.3896 Ω°C instead of ITS90 coefficients.

$$R0 = R0_{old} - (\Omega_{Meas} - 0.3896T)$$

Table 48. Effective Area Calculation Variables

VARIABLE	DEFINITION
R0 _{OLD}	The R0 value of the FPG PRT as determined in the previous calibration. The current value can be obtained by following the steps outlined in Section 8.5.4.
Ω _{Meas}	Measured 4-Wire resistance of the mounting post PRT. The PRT calibration cable should be connected to a calibrated DMM to measure this value.
T	The measured temperature of a calibrated temperature reference.

8.5.4 ENTER THE R0 VALUE INTO THE FPG TERMINAL

The R0 values obtained for each PRT must be entered into the FPG Terminal. Use the following key sequence on the FPG terminal to view or edit the R0 values of either of the mounting post PRTs.



The R0 values of the mounting post PRTs must be entered into the FPG Terminal. These values are not maintained or viewed by FPG Tools.

- ❶ Press **[0 Special]**.
- ❷ Press **[4 Internal]**.
- ❸ Press **[3 Std&PRTΩ]**.
- ❹ The R0 value for the upper mounting post PRT will display. Type in the new value and press **[Enter]**.
- ❺ The R0 value for the lower mounting post PRT will display. Type in the new value and press **[Enter]**.
- ❻ Press **[Enter]** 3 more times to step through the remaining screens without modifying the current values.
- ❼ Press **[2 Save]**.

8.5.5 REATTACH THE PRTS TO THE FPG

The PRTs should be replaced in the same position that they were removed from prior to calibration.

- ❶ Place the knurled nut on the PRT with the threaded section facing towards the tip of the PRT.
- ❷ Place the two O-rings on the PRT so that they are about 2 cm from the tip of the PRT.
- ❸ Repeat steps 1 and 2 for the remaining PRT.
- ❹ Connect the DIN connector on the PRT cable to the platform of the FPG. Screw the connector in fully clockwise.
- ❺ Place the upper PRT into the back of the upper mounting post. Partially thread the knurled nut into the mounting post.
- ❻ Gently press on the end of the PRT so that it slides to a stop in the mounting post. Tighten the knurled nut into the mounting post so that it is snug against the O-rings.
- ❼ Repeat steps ❹ through ❻ for the lower mounting post PRT.

8.6 PREPARING FOR STORAGE / SHIPMENT

This section describes the steps and recommended sequence for shutting the down the FPG8601 system and packaging it for long term storage and / or shipment.

8.6.1 FPG8601

- ❶ Return instrument to Gauge Mode.
- ❷ Click the shut down button in FPG Tools, wait for lube pressure to equal atmosphere.
- ❸ Turn off gas supplies and disconnect from FPG.
- ❹ Turn off electrical power.
- ❺ Remove external valving, vacuum sensor, and FPG Manifold from mounting post.
- ❻ Remove piston-cylinder (see Section 7).
- ❼ Replace orange plastic piston-cylinder blank into carriage assembly gimble ring.
- ❽ Re-attach lower mounting post and cover mounting post KF16 flanges with protective covers.
- ❾ Remove fittings / adaptors from rear of FPG.
- ❿ Drain water from Humidifier bubbler.
- ⓫ Individually wrap the FPG8601 base, vacuum sensor, and FPG Manifold in plastic before placing in the storage case.

8.6.2 VLPC

- ❶ Turn off power.
- ❷ Remove tubes and the adaptors / fittings from rear of VLPC.



Ensure that the o-rings on the VLPC bulkhead fittings remain.

- ❸ Wrap the VLPC in plastic before placing it in the storage case.

8.6.3 3-DUT MANIFOLD

- ❶ Ensure that the FPG is in gauge mode.
- ❷ Disconnect the manifold test lines from the FPG.
- ❸ Disconnect the DUTs from the manifold platform.
- ❹ Disconnect vacuum pump from underside of the manifold and cover the connection with a protective cap.
- ❺ Lower DUT jack stands.
- ❻ Remove the corrugated metal tubes cover the connections with protective caps.
- ❼ Wrap the 3-DUT manifold in plastic before placing the storage case.

NOTES



9. DATA FILES

9.1 OVERVIEW

Data files are the files created by FPG Tools to store data related to a test run, internal calibrations, tares, and program errors. Each data file has a specific file extension and in some cases a specific file name to denote the function of the file. With the exception of test data files, all data files must be stored in the root directory of FPG Tools. Test data files may reside in any selectable directory.

All files are designed to be easily exported into MS Excel or any other third party spreadsheet application. These tools are useful for plotting and reporting information specific to the data file. FPG Tools has limited plotting ability that can be used with "*.dat" files only (see Section 6.3.4).

9.2 POINT LOG DATA FILE (*.DAT)

*.dat files are generated when **[Run w/Point Log]** or **[Run Test Sequence]** (see Section 6.5) is selected. These files store current setup information as well as all data points logged by the user or a test sequence. The files are semi-colon delimited for easy import into other reporting and analysis applications. A separate file is created for each active DUT.

9.2.1 NAMING AND STORING DATA FILES

FPG Tools generates a default file name and location, however any file name and location can be selected. The default directory for "data" files is specified by the root, major and minor directory selections on the **<Data File>** tab of the system setup (see Section 6.6.2.3) when a DUT is active. When a DUT is not active, the default directory is the root directory selection.

The default *.dat file name follows the format **yyddd_aa.dat** where:

- yy** Is the two digit year (e.g. 2000 is represented by 00).
- ddd** Represents the Julian day. The value is the day of the year relative to the 365 day calendar (e.g., January 12 is represented by 012).
- aa** Represents the data file run number. This indicator increments from 01 to 99 allowing up to 99 tests to be run using the same base data file name.

9.2.2 FILE FORMAT

*.dat data files contain a header section and a data section. The header section of the file stores information setup at the beginning of a test sequence or test point log. The data section contains averaged or instantaneous data logged for each test point in the same order as on the **<Logged Data>** Run screen (see Section 6.3.5).

In some circumstances, the header section can change. Particularly, if **[Run w/Point Log]** is selected a user has the option to take points at will as well as change setup information and other specific settings (see Section 6.5.3). Keep this in mind when viewing the header section.

9.3 INTERNAL CALIBRATION LOG FILE

The internal calibration log file is named **"intcal.log"** and stored in the root directory of FPG Tools. This file contains a complete history of every internal calibration that was activated as well as calibrations that were logged only (see Section 5.3.2). All data displayed on the **<Internal Calibration Results>** form is stored in this file. The first line of the file is a list of column headings. Each subsequent line contains data specific to an internal calibration.

Realize the active calibration factor is logged for every data point in a *.dat file. This file is not required to simply view the calibration factor. It was conceived to troubleshoot problems and watch the calibration history of the load cell over time.



When viewing the "intcal.log" file, if the "Original K_Cal" value is not the same as the previous "New K_Cal" value, the last calibration was not activated.



If the "intcal.log" file becomes large, simply delete the file after verifying that there are no pending issues that this file may be used to resolve.

9.4 SYSTEM ZERO LOG FILE

The system zero log file is "**syszero.log**" and is stored in the root directory of FPG Tools. This data file contains the FPG zero information just prior to activating a new FPG zero. The pressure and temperature information stored in the file are the same as the values displayed in the **<Tare Values>** screen (see Section 6.3.3). However, the load cell output value "N", represents the zero offset of the load cell that was removed by taring. For automated tests, this offset can be used to make corrections on the FPG pressure.



If the "syszero.log" file becomes large, simply delete the file after verifying that there are no pending issues that this file may be used to resolve.

9.5 ERROR LOG FILE

The error log file is named "**FPG.err**" and is stored in the root directory of FPG Tools. All remote and calculation errors encountered by FPG Tools generate a new error line in the file. Each line includes a date and time stamp along with a specific error message.



DH Instruments technical service may request a copy of this file when troubleshooting problems.

This file is intended to be used as a troubleshooting aid for automated tests. If a test sequence is run overnight and the power goes out for several minutes; FPG Tools will recover and complete the test, however, there will be bad data in the data file. This file can track down when the outage occurred and how long it lasted.



If the "FPG.err" file becomes large, simply delete the file after verifying that there are no pending issues that this file may be used to resolve.



10. TROUBLESHOOTING

10.1 OVERVIEW

The FPG/VLPC combined with FPG Tools software is a sophisticated pressure control and measurement system. Before assuming that unexpected behavior is caused by a software or hardware defect, the operator should use the manual in conjunction with the documentation of any other instruments used with the system to troubleshoot the problem. The following section contains suggestions and solutions to resolve many commonly encountered issues. Identify the unexpected behavior from the symptoms list in Table 49. A probable cause and solution are proposed including cross references to sections in this manual that may be of assistance.

Table 49. Troubleshooting Tips

SYMPTOM	PROBABLE CAUSE	SOLUTION
Will not power up.	Blown fuse.	Replace fuse.
	Power not connected.	Plug in power cord.
FPG pressure is unstable at zero.	Dirty piston-cylinder.	Clean the piston-cylinder (see Section 7.4).
	Ambient condition unstable.	View tolerance codes on FPG software.
	Warm-up time not reached.	At least 30 minutes is required after changing measurement modes and purging.
Humidity is not within 40 to 70 %RH.	Bubbler's water chamber is empty.	Add water to the bubbler.
	Lubrication pressure is incorrect.	Make sure you have 700 kPa (100 psi) coming into the FPG. Make sure you are in the correct calibration mode (gauge or absolute).
	Lubrication volume is not properly purged.	Purge the FPG using the [Purge] toolbar function.
Temperature is displaying an inaccurate value.	PRT disconnected.	Make sure the PRT cable is connected to the PRT connector on the front of the FPG and that the PRT's are securely connected to the mounting post.
Lubrication pressure is too low.	Supply pressure is too low.	Make sure supply pressure is at least 700 kPa (100 psi).
FPG pressure seemed to have shifted.	FPG has tilted further than FPG tilt specification.	Readjust the FPG using the bubble level on the top of the mounting post.
Temperature rate is too high.	Ambient temperature is fluctuating too much.	Remedy the ambient temperature oscillation.
FPG pressure is always "Not Ready" and a string of characters displays on the <Run Diagnostics><Status> value.	One of many internal limits could have been reached.	Use the status information to determine what limits have been reached (see Section 6.3.7). Also verify that the limits setup in FPG Tools are not too restrictive (see Section 6.6.4).
FPG pressure is always "Not Ready" and only an "R" displays on the <Run Diagnostics><Status> value.	The stability or hold setting is too tight.	Use [Config] , [Settings] to change the hold and stability settings.
	The VLPC is unable to reach the target pressure because of improper plumbing to a DUT or the supply pressure is too low.	Make sure that any DUT bypass valve is closed and that all DUT connections to the mounting post are correct for the type of DUT in use (see Section 4.10). The VLPC must contain a properly regulated gas supply (see Section 4.8)
	The piston is dirty. This is more obvious when the FPG is fully vented and the pressure is still unstable.	Clean the FPG piston (see Section 7).
Bubbles keep coming through the	FPG is in purge mode.	Normal behavior.

SYMPTOM	PROBABLE CAUSE	SOLUTION
bubbler although lubrication pressure is stable.	Normal when transitioning from one mode to the another.	Normal behavior.
	There is a leak in the lubrication volume.	Make sure the lubricating volume and mounting post are properly connected.
When in absolute mode the reference pressure is too high.	Possible leak in vacuum setup.	Make sure the vacuum and manifold connections are tight.
	Ballast is open on vacuum pump.	Close ballast on vacuum pump.
	Vacuum reference sensor is not properly connected, or activated.	Make sure the vacuum reference sensor is connected to the isolation valve and the lower mounting post. The power connection between the sensor and the FPG must also be secure.
Bubbler water was added, yet it is now empty.	Supply pressure was turned off or is too low.	Make sure that the FPG supply pressure is always on, and above 700 kPa (100 psi).
I aborted an internal calibration and the internal calibration mass is still lowered.	To abort an internal calibration, only press [Operation Abort] one time. Repeatedly pressing it will force an early abort and not allow FPG Tools to raise the calibration mass.	If FPG Tools is in the diagnostics user level (see Section 6.3.7), press the up arrow on the main program functions toolbar (see Section 6.6.4). If FPG Tools is not in the diagnostics user level, vent all pressure and return to gauge measurement mode. Then cycle power on the FPG. Leave the power off at least 5 seconds before turning it back on.
The DUT output displayed in FPG Tools doesn't match the displayed DUT output.	The DUT was setup with an adder and a multiplier.	Normal behavior (see Section 6.8).
	The leading characters to strip or output command is incorrect for the DUT.	Use the [Remote Communications] option to view the actual output of the DUT. Then edit the DUT <Leading characters to strip> and <Command> fields to properly accommodate the DUT output.
The DUT output always displays "Error" on the <Run Display> in FPG Tools.	The DUT RS232 or IEEE-488 connection is incorrect.	Make sure the remote interface to the DUT is secure.
	The DUT interface was not setup in FPG Tools.	Use [Config], [System Setup], <Interface> to setup the remote interface to the DUT. Make sure the RS232 or IEEE-488 settings are correct (see Section 6.6.2.2).
An communications error occurs interfacing with the FPG8601 and FPG Tools.	The RS232 cable is not connected.	The COM1 port of the FPG should be connected to a COM port on the host PC.
	The COM port setup in FPG Tools is not the COM port that the FPG is connected to.	The port on the host PC must be specified using the [Config], [System Setup], <Interface> option. The default port settings "19200,N,8,1" will work as long the FPG settings are not modified on the FPG remote terminal.
The <VLPC Control> window is disabled.	The VLPC is not enabled in FPG Tools.	Check the [Config], [System Setup], <Enable VLPC> option (see Section 6.6.2.1).
	The VLPC is currently executing a function.	Check the status bar to determine what operation is active. If necessary, use the [Operation Abort] option to end a task that will not complete.
A message displays regarding a communications error with the VLPC.	The RS232 cable is not connected.	A standard RS232 cable must connect the FPG COM2 port to the VLPC COM1 port. If this connection is not present, FPG Tools will not operate the VLPC.
	The VLPC is not turned on.	There is no indication as to whether or not the VLPC is turned on. Make sure the power cord is connected and the "1" is down on the power switch.
VLPC's valves will not actuate.	Shop air supply pressure too low.	Check that compressor is operational and outputting a pressure of at least 700 kPa (100 psi).

11. APPENDIX



11.1 INTERNAL VALVES

The state of the 16 supported internal valves can be controlled using the valve control toolbar (see Section 6.4.3). This section is provided to define the function of each of the valves.



Manually adjusting the states of individual valves requires a thorough understanding of the FPG pneumatic circuit. Actuating valves in the wrong sequence can cause damage and/or contamination to the FPG.

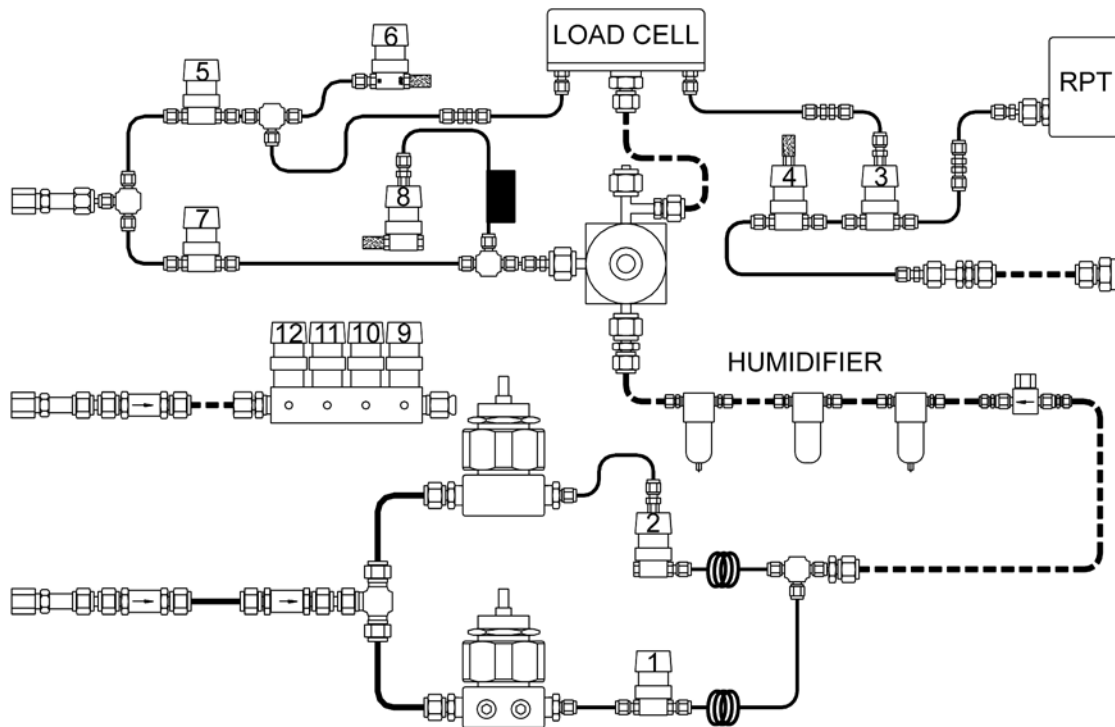

Figure 67. FPG Internal Valve Configuration

Table 50. Internal Valve Descriptions

VALVE	DESCRIPTION
1	This valve is activated to use the absolute mode regulator to supply pressure to the FPG lubricating volume. In gauge mode the valve is closed.
2	This normally open valve is opened to use the gauge mode regulator to supply pressure to the FPG lubricating volume.
3	A three way valve used to allow the internal transducer to read the lubrication pressure in the lubricating volume. The normal state of the valve is to read the lubrication pressure. When the valve is activated, the internal transducer will either measure atmosphere, or the pressure in the lower mounting post, depending on the state of valve 4.
4	A three way valve used to allow the internal transducer to read atmosphere or the pressure in the lower mounting post. The normal state of the valve is to read atmosphere. Valve 3 must first be engaged before this valve can be used to change the pressure supplied to the internal transducer.
5	Valve 5 evacuates the lubrication volume when actuated. This valve is used during the transition to absolute mode and during absolute mode purging.
6	A normally open valve used to vent all pressure in the lubricating volume to atmosphere. This valve is opened when the [Shut Down] icon is used and during purging in gauge mode.
7	Connects the LNI Regulator to vacuum for absolute mode operation. This regulator is adjusted to maintain a 40 kPa pressure relative to the pressure on it's reference port. Therefore in absolute mode, the lubrication pressure is approximately 40 kPa. When a vacuum pump is on, this valve should never be opened at the same time as valve 8.
8	Connects the LNI Regulator to atmosphere for gauge mode operation. This regulator is adjusted to maintain a 40 kPa pressure relative to the pressure on it's reference port. Therefore in gauge mode, the lubrication pressure is approximately 140 kPa. When a vacuum pump is on, this valve should never be opened at the same time as valve 7.
9	Controls the vacuum reference isolation valve on the bottom of the FPG mounting post. The pneumatic driver for this valve is on the FPG base.
10	Controls the normally open pneumatic bypass valve on the FPG manifold. The valve is activated to read a pressure and deactivated to return to a zero pressure condition. The pneumatic driver for this valve is on the FPG base.
11	Controls the pneumatic vacuum reference control valve on the FPG manifold. VLPC absolute pressure range 1 requires this valve to be actuated. FPG Tools automatically toggles the state of this valve based on the current operation. The pneumatic driver for this valve is on the FPG base.
12	Controls the vacuum reference sensor isolation valve on the front of the lower mounting post. FPG Tools actuates this valve to allow the vacuum reference sensor to measure the pressure in the lower mounting post. The pneumatic driver for this valve is on the FPG base.

11.2 UNIT CONVERSIONS

FPG pressure display units are selected using the **[Units]** menu option. All internal pressure calculations are performed in Pa and converted to the selected pressure unit for display purposes.

The table below provides the conversion coefficients used by FPG Tools to convert numerical values expressed in Pa to corresponding values expressed in other units. Dividing a pressure in a given pressure unit by the "Multiply by" factor expresses the pressure in Pa.

Table 51. Unit Conversion Factors

TO CONVERT FROM PA TO		MULTIPLY BY
mPa	<i>Milli Pascal</i>	1000
Pa	<i>Pascal</i>	1.0
Mbar	<i>Millibar</i>	1.0 E-02
kPa	<i>kilo Pascal</i>	1.0 E-03
Bar	<i>Bar</i>	1.0 E-05
mmWa @ 4°C	<i>millimeter of water</i>	1.019716 E-01
mmHg @ 0°C	<i>millimeter of mercury</i>	7.50063 E-03
psi	<i>pound per square inch</i>	1.450377 E-04
psf	<i>pound per square foot</i>	1.007206 E-06
inWa @ 4°C	<i>inch of water</i>	4.014649 E-03
inWa @ 20°C	<i>inch of water</i>	4.021732 E-03
inWa @ 60°F	<i>inch of water</i>	4.018429 E-03
inHg @ 0°C	<i>inch of mercury</i>	2.953 E-04
kcm ²	<i>kilogram force per centimeter square</i>	1.019716 E-05
User	<i>User</i>	User defined coefficient

11.3 FPG8601 PRESSURE CALCULATIONS

11.3.1 COMPENSATED PRESSURES

The FPG calculates compensated pressures (seen at the DUT, without thermal transpiration correction*) following:

$$P_G = \Delta P_{FPG,G} - (\rho_{hi} - \rho_{ref})gh_D$$

$$P_{AD} = \Delta P_{FPG,A} - \rho_{hi}gh_D$$

$$P_A = \Delta P_{FPG,A} + P_{ref} - \rho_{hi}gh_D$$

*Thermal transpiration correction is applied when specified by the user. See Section 11.3.4.

11.3.2 DIFFERENTIAL PRESSURES

Differential pressures ($P_{hi}-P_{ref}$), at the FPG reference level, are defined following:

$$\Delta P_{FPG,G} = \frac{\Delta F}{A_\theta} = \frac{K_{cal} \cdot (N + \delta N_1 + \delta N_2 + \delta N_3)}{A_{20} \cdot [1 + (\alpha_p + \alpha_c)(\theta - 20)]}$$

$$\Delta P_{FPG,A} = \frac{\Delta F}{A_\theta} = \frac{K_{cal} \cdot (N + \delta N_1 + \delta N_2)}{A_{20} \cdot [1 + (\alpha_p + \alpha_c)(\theta - 20)]}$$

11.3.3 CORRECTION TERMS

Corrections to the balance output based on changes in buoyancy and drag on the piston, carriage and load cell are calculated following:

$$\delta N_1 = -K_b \cdot (P_{lub} - P_{lub,0})$$

$$\delta N_2 = K_d \cdot [(P_{lub} - P_{ref}) - (P_{lub,0} - P_{ref,0})]$$

$$\delta N_3 = V_{ext} \cdot g \cdot \left[\left(\frac{P_{ref}}{T_{ref}} \right) - \left(\frac{P_{ref,0}}{T_{ref,0}} \right) \right] \cdot \frac{M_{gas}}{K_{cal} \cdot Z_{ref,0} \cdot R}$$

11.3.4 THERMAL TRANSPARATION CORRECTION

For pressures below 133 Pa (1 Torr) and DUT temperatures above ambient there is a difference in pressure between the DUT and the FPG. This effect, known as thermal transpiration, can cause differences of up to 4 % of reading between the FPG and the DUT. Transpiration correction allows the FPG to calculate the pressure which is actually seen at the DUT. The calculations below follow the conventions described in “Thermal transpiration correction in capacitance manometers¹”.

Note that calculation of X_{hi} and X_{ref} require iteration since both are a function of the DUT (corrected) pressure. The procedure (for X_{hi} for example) is to use the uncorrected pressure, P_A in the first calculation (see Section 11.3.1), then calculate $P_{A,T}$. The resulting value of $P_{A,T}$ is then used for another calculation of X_{hi} . This process converges very quickly and 3 cycles is sufficient to achieve convergence 2 orders of magnitude below the system resolution at all pressures.

$$P_{A,T} = P_A \cdot \left[\frac{AX_{hi}^2 + BX_{hi} + C\sqrt{X_{hi}} + \sqrt{\frac{T_{DUT}}{T_{ref}}}}{AX_{hi}^2 + BX_{hi} + C\sqrt{X_{hi}} + 1} \right]$$

$$P_{ref,T} = P_{ref} \cdot \left[\frac{AX_{ref}^2 + BX_{ref} + C\sqrt{X_{ref}} + \sqrt{\frac{T_{DUT}}{T_{ref}}}}{AX_{ref}^2 + BX_{ref} + C\sqrt{X_{ref}} + 1} \right]$$

$$P_{AD,T} = P_{A,T} - P_{ref,T}$$

$$X_{hi} = \frac{P_{A,T} d}{0.133}$$

$$X_{ref} = \frac{P_{ref,T} d}{0.133}$$

$$A = \hat{A} \bar{T}^{-2}$$

$$B = \hat{B} \bar{T}^{-1}$$

$$C = \hat{C} \bar{T}^{-0.5}$$

$$\bar{T} = \frac{(T_{DUT} + T_{ref})}{2}$$

1. KF Poulter, et al, *Vacuum*, 1983, 33:311-316

Table 52. FPG Defined Pressure Calculation Variables

VARIABLE	UNITS	DESCRIPTION
\hat{A}	$K^2 \cdot (\text{Torr} \cdot \text{mm})^{-2}$	Reduced constant for transpiration (value for N_2 : $1.20 \cdot 10^6$)
\hat{B}	$K \cdot (\text{Torr} \cdot \text{mm})^{-1}$	Reduced constant for transpiration (value for N_2 : $1.00 \cdot 10^3$)
\hat{C}	$K^{0.5} \cdot (\text{Torr} \cdot \text{mm})^{-0.5}$	Reduced constant for transpiration (value for N_2 : 14.0)
\bar{T}	K	Average gas temperature for transpiration correction
A	$(\text{Torr} \cdot \text{mm})^2$	Constant for transpiration
A_{20}	m^2	Effective area of piston-cylinder at 20 °C
A_θ	m^2	Effective area of piston-cylinder at temperature θ
B	$(\text{Torr} \cdot \text{mm})^{-1}$	Constant for transpiration
C	$(\text{Torr} \cdot \text{mm})^{-0.5}$	Constant for transpiration
d	m	Smallest internal diameter in DUT – where temperature transition occurs
g	m/s^2	Local acceleration of gravity
h_D	m	DUT height – distance of DUT above FPG reference level (negative if below)
K_b	cnt/Pa	Buoyancy coefficient: quantifying the effect of change in lubrication pressure ($K_b > 0$)
K_{cal}	N/cnt	Calibration coefficient of load cell (depends on calibration conditions)
K_d	cnt/Pa	Drag coefficient: quantifying the effect of change in differential lubrication pressure across piston ($K_d > 0$)
m_{cal}	kg	True mass of internal calibration mass
M_{gas}	mol^{-1}	Molar mass of test gas
N	cnt	Number of counts output by load cell representing force measured (1 count = 1 mg under calibration conditions)
N_{cal}	cnt	Number of counts output by load cell after lowering internal calibration mass
P_A	Paa	Pressure at DUT in absolute mode
$P_{A,T}$	Pa	Pressure at DUT with transpiration correction
P_{AD}	Pa	Differential pressure at DUT in absolute differential mode
$P_{AD,T}$	Pa	Absolute differential pressure at DUT with transpiration correction
P_G	Pa	Pressure at DUT in gauge mode
P_{lub}	Paa	Lubrication pressure
P_{ref}	Paa	Reference pressure (lower mounting post) measured by atmospheric pressure sensor in gauge mode and residual vacuum sensor in absolute mode
$P_{ref,0}$	Paa	Reference pressure at tare
$P_{ref,T}$	Paa	Reference pressure with transpiration correction
R	$N \cdot m / mol \cdot K$	Universal gas constant (= 8314.411)
T_{DUT}	K	Temperature of DUT (i.e., head temperature)
T_{ref}	K	Temperature of reference pressure gas

VARIABLE	UNITS	DESCRIPTION
$T_{ref,0}$	K	Temperature of reference pressure gas at tare
V_{ext}	m ³	Total external volume of piston
X_{hi}	Torr•mm	Pressure geometry factor for transpiration – P _{hi}
X_{ref}	Torr•mm	Pressure geometry factor for transpiration - P _{ref}
$Z_{ref,0}$	-	Compressibility of reference pressure gas at tare
ΔF	N	Net change in force (from tare) on piston
$\Delta P_{FPG,A}$	Pa	Differential pressure between high and reference test ports at FPG reference level in absolute mode
$\Delta P_{FPG,G}$	Pa	Differential pressure between high and reference test ports at FPG reference level in gauge mode
α_C	°C ⁻¹	Linear thermal expansion coefficient of cylinder
α_P	°C ⁻¹	Linear thermal expansion coefficient of piston
δN_1	cnt	Correction to N resulting from change in buoyancy of piston, load cell and linkage due to change in lubrication pressure
δN_2	cnt	Correction to N resulting from change in drag force on piston due to change in difference between lubrication pressure and test pressures
δN_3	cnt	Correction to N resulting from change in buoyancy of piston due to change in reference pressure
θ	°C	Temperature of piston-cylinder
ρ_{hi}	kg/m ³	Density of high pressure test gas (upper mounting post)
ρ_{lub}	kg/m ³	Density of lubrication gas
ρ_m	kg/m ³	Density of internal mass
ρ_{ref}	kg/m ³	Density of reference pressure test gas (lower mounting post)

11.3.5 SAMPLE CALCULATIONS

Included with FPG Tools PC software is a sample calculation spreadsheet, "FPGCalcs.xls". This spreadsheet includes pressure calculations in gauge, absolute and absolute differential measurement modes. Use the spreadsheet to better understand the FPG pressure calculations and to recalculate the FPG pressure under different circumstances.

11.3.5.1 GAUGE PRESSURE

Pressure Determination						
	Variable	Entered		Calculated		Description
		Value	Units	Value	Units	
Setup	Mode	G				G=gauge, AD=Absolute Differential, A=Absolute
	Gas	Air				Working gas (Air or N2)
	M(gas)	28.959	1/mole			Molar mass of gas
	$\alpha(p) + \alpha(c)$	9.00E-06	1/K			Linear thermal expansivity of piston + cylinder
	Vext	4.9394E-05	m ²			External volume of piston
	g	9.79474	m/s ²			Local acceleration of gravity
	A(20)	0.00098053	m ²			Effective area of piston/cylinder at 20 °C
	Kb	0.005699	cnt/Pa			Buoyancy proportional coefficient
	Kd	1.00E-04	cnt/Pa			Drag force proportional coefficient
	h(D)	-20	cm	-0.2	m	Height of DUT above VLPPS reference level
K(cal)	9.793429E-06	N/cnt			Load cell calibration coefficient	
Readings	Plub	141.5	kPa	141500	Pa	Lubrication pressure
	Plub(0)	141	kPa	141000	Pa	Lubrication pressure at time of tare
	Pref	97.5	kPa	97500	Pa	Reference pressure (gas in lower mounting post)
	Pref(0)	98	kPa	98000	Pa	Reference pressure at time of tare
	Θ	23.5	°C			Piston/cylinder temperature (mounting post)
	Θ(0)	24	°C			Piston/cylinder temperature at time of tare
	N	1000000	cnt			Load cell output in counts (1 count = 1 mg at cal)
Intermediate Calculations	Tref			296.65	K	Reference temperature (mounting post)
	Tref(0)			297.15	K	Reference temperature at time of tare
	A(Θ)			0.000980561	m ²	Effective area at temperature Θ
	Z(0)			0.99969	-	Compressibility of reference gas at tare
	δN(1)			-2.8	cnt	Correction to N due to change in Plub
	δN(2)			0.1	cnt	Correction to N due to change in (Plub-Pref)
	δN(3)			-0.2	cnt	Correction to N due to change in Pref
	P(hi)			107487.5	Pa	Pressure in upper chamber
	ρ(hi)			1.262472437	kg/m ³	Density of gas in upper mounting post
	ρ(ref)			1.145129422	kg/m ³	Density of reference gas
	ΔP(FPG,G)			9987.546	Pa	Differential pressure (upper-lower) in gauge mode
ΔP(FPG,A)			9987.548	Pa	Differential pressure (upper-lower) in absolute mode	
Results	P(G)			9987.776	Pa	Gauge pressure at DUT
	P(AD)			9990.021	Pa	Absolute differential pressure at DUT
	P(A)			107490.021	Pa	Absolute pressure at DUT

11.3.5.2 ABSOLUTE PRESSURE

Pressure Determination							
Setup	Variable	Entered		Calculated		Description	
		Value	Units	Value	Units		
Setup	Mode	A				G=gauge, AD=Absolute Differential, A=Absolute	
	Gas	N2				Working gas (Air or N2)	
	M(gas)	28.016	1/mole			Molar mass of gas	
	$\alpha(p) + \alpha(c)$	9.00E-06	1/K			Linear thermal expansivity of piston + cylinder	
	Vext	4.9394E-05	m ³			External volume of piston	
	g	9.79474	m/s ²			Local acceleration of gravity	
	A(20)	0.00098053	m ²			Effective area of piston/cylinder at 20 °C	
	Kb	0.005699	cnt/Pa			Buoyancy proportional coefficient	
	Kd	1.00E-04	cnt/Pa			Drag force proportional coefficient	
	h(D)	-10	cm	-0.1	m	Height of DUT above VLPPS reference level	
Readings	K(cal)	9.793429E-06	N/cnt			Load cell calibration coefficient	
	Plub	40	kPa	40000	Pa	Lubrication pressure	
	Plub(0)	40.5	kPa	40500	Pa	Lubrication pressure at time of tare	
	Pref	0.0005	kPa	0.5	Pa	Reference pressure (gas in lower mounting post)	
	Pref(0)	0.00048	kPa	0.48	Pa	Reference pressure at time of tare	
	Θ	23	°C			Piston/cylinder temperature (mounting post)	
	$\Theta(0)$	23.5	°C			Piston/cylinder temperature at time of tare	
	N	1000000	cnt			Load cell output in counts (1 count = 1 mg at cal)	
	Intermediate Calculations	Tref			296.15	K	Reference temperature (mounting post)
		Tref(0)			296.65	K	Reference temperature at time of tare
A(Θ)				0.000980557	m ²	Effective area at temperature Θ	
Z(0)				1.00000	-	Compressibility of reference gas at tare	
$\delta N(1)$				2.8	cnt	Correction to N due to change in Plub	
$\delta N(2)$				-0.1	cnt	Correction to N due to change in (Plub-Pref)	
$\delta N(3)$				0.0	cnt	Correction to N due to change in Pref	
P(hi)				9988.1	Pa	Pressure in upper chamber	
$\rho(hi)$				0.113644712	kg/m ³	Density of gas in upper mounting post	
$\rho(ref)$				5.68886E-06	kg/m ³	Density of reference gas	
Results	$\Delta P(FPG,G)$			9987.649	Pa	Differential pressure (upper-lower) in gauge mode	
	$\Delta P(FPG,A)$			9987.649	Pa	Differential pressure (upper-lower) in absolute mode	
	P(G)			9987.760	Pa	Gauge pressure at DUT	
P(AD)			9987.760	Pa	Absolute differential pressure at DUT		
P(A)			9988.260	Pa	Absolute pressure at DUT		

Thermal Transpiration Correction						
Setup	Variable	Entered		Calculated		Description
		Value	Units	Value	Units	
Setup	A*	1200000	K ² (Torr.mm) ⁻²			Reduced constant for transpiration
	B*	1000	K(Torr.mm) ⁻¹			Reduced constant for transpiration
	C*	14	K ^{0.5} (Torr.mm) ^{-0.5}			Reduced constant for transpiration
	d	4	mm	0.004	m	Smallest internal diameter of DUT (temperature transition)
	T(DUT)	45	°C	318.15	K	Temperature of DUT head
Calculations	T*			307.15	K	Average temperature
	A			12.71979777	(Torr.mm) ⁻²	Transpiration constant
	B			3.255738239	(Torr.mm) ⁻¹	Transpiration constant
Iterative Calculations	C			0.798827074	(Torr.mm) ^{-0.5}	Transpiration constant
	Xhi(1)			300.398792	Torr.mm	Pressure geometry factor, hi test pressure, iteration 1
	Yhi(1)			1148819.220	-	$AX_{hi}^2 + BX_{hi} + CX_{hi}^{0.5}$
	Ratio, hi(1)			1.000000	-	P(DUT)/P(FPG), hi test pressure, iteration 1
	P(A,T)(1)			9988.260150	Pa	Absolute pressure, iteration 1
	Xhi(2)			300.398802	Torr.mm	Pressure geometry factor, hi test pressure, iteration 2
	Yhi(2)			1148819.293	-	$AX_{hi}^2 + BX_{hi} + CX_{hi}^{0.5}$
	Ratio, hi(2)			1.000000	-	P(DUT)/P(FPG), hi test pressure, iteration 2
	P(A,T)(2)			9988.260150	Pa	Absolute pressure, iteration 2
	Xhi(3)			300.398802	Torr.mm	Pressure geometry factor, hi test pressure, iteration 3
	Yhi(3)			1148819.293	-	$AX_{hi}^2 + BX_{hi} + CX_{hi}^{0.5}$
	Ratio, hi(3)			1.000000	-	P(DUT)/P(FPG), hi test pressure, iteration 3
	Xref(1)			0.015038	Torr.mm	Pressure geometry factor, ref test pressure, iteration 1
	Yref(1)			0.149793	-	$AX_{ref}^2 + BX_{ref} + CX_{ref}^{0.5}$
	Ratio, ref(1)			1.031726	-	P(DUT)/P(FPG), ref test pressure, iteration 1
	P(ref,T)(1)			0.515863	Pa	Reference pressure, iteration 1
	Xref(2)			0.015515	Torr.mm	Pressure geometry factor, ref test pressure, iteration 2
	Yref(2)			0.153074	-	$AX_{ref}^2 + BX_{ref} + CX_{ref}^{0.5}$
	Ratio, ref(2)			1.031635	-	P(DUT)/P(FPG), ref test pressure, iteration 2
	P(ref,T)(2)			0.515818	Pa	Reference pressure, iteration 2
Xref(3)			0.015513	Torr.mm	Pressure geometry factor, ref test pressure, iteration 3	
Yref(3)			0.153064	-	$AX_{ref}^2 + BX_{ref} + CX_{ref}^{0.5}$	
Ratio, ref(3)			1.031636	-	P(DUT)/P(FPG), ref test pressure, iteration 3	
P(ref,T)(3)			0.515818	Pa	Reference pressure, iteration 3	
Results	P(A,T)			9988.260	Pa	Absolute pressure with transpiration correction
	P(AD,T)			9987.744	Pa	Absolute differential pressure with transpiration correction

11.3.5.3 ABSOLUTE DIFFERENTIAL PRESSURE

Pressure Determination						
	Variable	Entered		Calculated		Description
		Value	Units	Value	Units	
Setup	Mode	AD				G=gauge, AD=Absolute Differential, A=Absolute
	Gas	N2				Working gas (Air or N2)
	M(gas)	28.016	1/mole			Molar mass of gas
	$\alpha(p) + \alpha(c)$	9.00E-06	1/K			Linear thermal expansivity of piston + cylinder
	Vext	4.9394E-05	m ³			External volume of piston
	g	9.79474	m/s ²			Local acceleration of gravity
	A(20)	0.00098053	m ²			Effective area of piston/cylinder at 20 °C
	Kb	0.005699	cnt/Pa			Buoyancy proportional coefficient
	Kd	1.00E-04	cnt/Pa			Drag force proportional coefficient
	h(D)	-10	cm	-0.1	m	Height of DUT above VLPPS reference level
	K(cal)	9.793429E-06	N/cnt			Load cell calibration coefficient
Readings	Plub	40	kPa	40000	Pa	Lubrication pressure
	Plub(0)	40.5	kPa	40500	Pa	Lubrication pressure at time of tare
	Pref	0.0005	kPa	0.5	Pa	Reference pressure (gas in lower mounting post)
	Pref(0)	0.00048	kPa	0.48	Pa	Reference pressure at time of tare
	Θ	23	°C			Piston/cylinder temperature (mounting post)
	$\Theta(0)$	23.5	°C			Piston/cylinder temperature at time of tare
	N	1000000	cnt			Load cell output in counts (1 count = 1 mg at cal)
Intermediate Calculations	Tref			296.15	K	Reference temperature (mounting post)
	Tref(0)			296.65	K	Reference temperature at time of tare
	A(Θ)			0.000980557	m ²	Effective area at temperature Θ
	Z(0)			1.00000	-	Compressibility of reference gas at tare
	$\delta N(1)$			2.8	cnt	Correction to N due to change in Plub
	$\delta N(2)$			-0.1	cnt	Correction to N due to change in (Plub-Pref)
	$\delta N(3)$			0.0	cnt	Correction to N due to change in Pref
	P(hi)			9988.1	Pa	Pressure in upper chamber
	$\rho(hi)$			0.113644712	kg/m ³	Density of gas in upper mounting post
	$\rho(ref)$			5.68886E-06	kg/m ³	Density of reference gas
	$\Delta P(FPG,G)$			9987.649	Pa	Differential pressure (upper-lower) in gauge mode
	$\Delta P(FPG,A)$			9987.649	Pa	Differential pressure (upper-lower) in absolute mode
	Results	P(G)			9987.760	Pa
P(AD)				9987.760	Pa	Absolute differential pressure at DUT
P(A)				9988.260	Pa	Absolute pressure at DUT

Thermal Transpiration Correction						
	Variable	Entered		Calculated		Description
		Value	Units	Value	Units	
Setup	A*	1200000	K ² (Torr.mm) ⁻²			Reduced constant for transpiration
	B*	1000	K(Torr.mm) ⁻¹			Reduced constant for transpiration
	C*	14	K ^{0.5} (Torr.mm) ^{-0.5}			Reduced constant for transpiration
	d	4	mm	0.004	m	Smallest internal diameter of DUT (temperature transition)
	T(DUT)	45	°C	318.15	K	Temperature of DUT head
Calculations	T*			307.15	K	Average temperature
	A			12.71979777	(Torr.mm) ⁻²	Transpiration constant
	B			3.255738239	(Torr.mm) ⁻¹	Transpiration constant
	C			0.798827074	(Torr.mm) ^{-0.5}	Transpiration constant
Iterative Calculations	Xhi(1)			300.398792	Torr.mm	Pressure geometry factor, hi test pressure, iteration 1
	Yhi(1)			1148819.220	-	$AX_{hi}^2 + BX_{hi} + CX_{hi}^{0.5}$
	Ratio, hi(1)			1.000000	-	P(DUT)/P(FPG), hi test pressure, iteration 1
	P(A,T)(1)			9988.260150	Pa	Absolute pressure, iteration 1
	Xhi(2)			300.398802	Torr.mm	Pressure geometry factor, hi test pressure, iteration 2
	Yhi(2)			1148819.293	-	$AX_{hi}^2 + BX_{hi} + CX_{hi}^{0.5}$
	Ratio, hi(2)			1.000000	-	P(DUT)/P(FPG), hi test pressure, iteration 2
	P(A,T)(2)			9988.260150	Pa	Absolute pressure, iteration 2
	Xhi(3)			300.398802	Torr.mm	Pressure geometry factor, hi test pressure, iteration 3
	Yhi(3)			1148819.293	-	$AX_{hi}^2 + BX_{hi} + CX_{hi}^{0.5}$
	Ratio, hi(3)			1.000000	-	P(DUT)/P(FPG), hi test pressure, iteration 3
	Xref(1)			0.015038	Torr.mm	Pressure geometry factor, ref test pressure, iteration 1
	Yref(1)			0.149793	-	$AX_{ref}^2 + BX_{ref} + CX_{ref}^{0.5}$
	Ratio, ref(1)			1.031726	-	P(DUT)/P(FPG), ref test pressure, iteration 1
	P(ref,T)(1)			0.515863	Pa	Reference pressure, iteration 1
	Xref(2)			0.015515	Torr.mm	Pressure geometry factor, ref test pressure, iteration 2
	Yref(2)			0.153074	-	$AX_{ref}^2 + BX_{ref} + CX_{ref}^{0.5}$
	Ratio, ref(2)			1.031635	-	P(DUT)/P(FPG), ref test pressure, iteration 2
P(ref,T)(2)			0.515818	Pa	Reference pressure, iteration 2	
Xref(3)			0.015513	Torr.mm	Pressure geometry factor, ref test pressure, iteration 3	
Yref(3)			0.153064	-	$AX_{ref}^2 + BX_{ref} + CX_{ref}^{0.5}$	
Ratio, ref(3)			1.031636	-	P(DUT)/P(FPG), ref test pressure, iteration 3	
P(ref,T)(3)			0.515818	Pa	Reference pressure, iteration 3	
Results	P(A,T)			9988.260	Pa	Absolute pressure with transpiration correction
	P(AD,T)			9987.744	Pa	Absolute differential pressure with transpiration correction

11.3.5.4 INTERNAL CALIBRATION (KCAL)

Internal Calibration					
Variable	Entered		Calculated		Description
	Value	Units	Value	Units	
m(cal)	776.484	g	0.776484	kg	True mass of internal calibration mass
p(m)	7900	kg/m ³			Density of calibration mass
g	9.79474	m/s ²			Local acceleration of gravity
N(cal)	776432	cnt			Balance indication when dropping mass (tare conditions)
p(lub)			0.455147	kg/m ³	Density of lubrication gas
K(cal)			9.7948316E-06	N/cnt	New K(cal) based on recalibration at tare conditions

11.4 DECLARATION OF CONFORMITY

We, **DH Instruments, a Fluke Company**, located at 4765 East Beautiful Lane, Phoenix AZ 85044-5318, USA, declare under a sole responsibility that the **FPG/VLPC SYSTEM** to which this declaration relates, meets the essential health and safety requirements, is in conformity with and the CE Marking has been applied according to the relevant EC Directives listed below using the relevant section of the following EC standards and other normative documents.

EU EMC Directive 89/336/EEC

Essential health and safety requirements relating to electromagnetic compatibility

- EN 61326-1** Electrical Equipment for Measurement, Control and Laboratory Use – EMC Requirements
- EN 61000-4-2 Electromagnetic Compatibility (EMC) – Electrostatic Discharge
- EN 61000-4-3 Electromagnetic Compatibility (EMC) – Radiated, Radio-Frequency, Electromagnetic Field Immunity Test
- EN 61000-4-4 Electromagnetic Compatibility (EMC) – Electrical Fast Transient/Burst Immunity Test
- EN 61000-4-5 Electromagnetic Compatibility (EMC) – Surge Immunity Test
- EN 61000-4-6 Electromagnetic Compatibility (EMC) – Immunity to Conducted Disturbances, Induced by Radio-Frequency Fields
- EN 61000-4-8 Electromagnetic Compatibility (EMC) – Power Frequency Magnetic Field Immunity Test
- EN 61000-4-11 Electromagnetic Compatibility (EMC) – Voltage Dips, Short Interruptions and Voltage Variations Immunity Tests
- CISPR 22** Limits and Methods of Measurement of Radio Disturbance Characteristics of Information Technology Equipment
- EN 61000-3-2** Limits for Harmonic Current Emissions
- EN 61000-3-3** Limitation of Voltage Fluctuations and Flicker in Low-Voltage Supply Systems for Equipment with Rated Current ≤ 16A

Low Voltage Directive EN 61010-1: 1993

Safety Requirements for Electrical Equipment for Measurement, Control, and Laboratory Use

The EMC and Safety tests listed above were performed by **Intertek Testing Services NA, Inc.** The results of these tests are contained in reports on file at **DH Instruments, a Fluke Company** and are available upon request.

11.5 GROUNDING / ELECTRICAL SCHEMATICS

The following schematics show the grounding and electrical signal paths of the FPG8601 system as a whole including the pumps, DUTs, and Ion gauge. More detailed schematics are given separately for the FPG and VLPC. Both the FPG and VLPC use a power entry module with an integrated slow-blow 1 Amp, 250 VAC fuse.

11.5.1 SYSTEM LEVEL GROUNDING

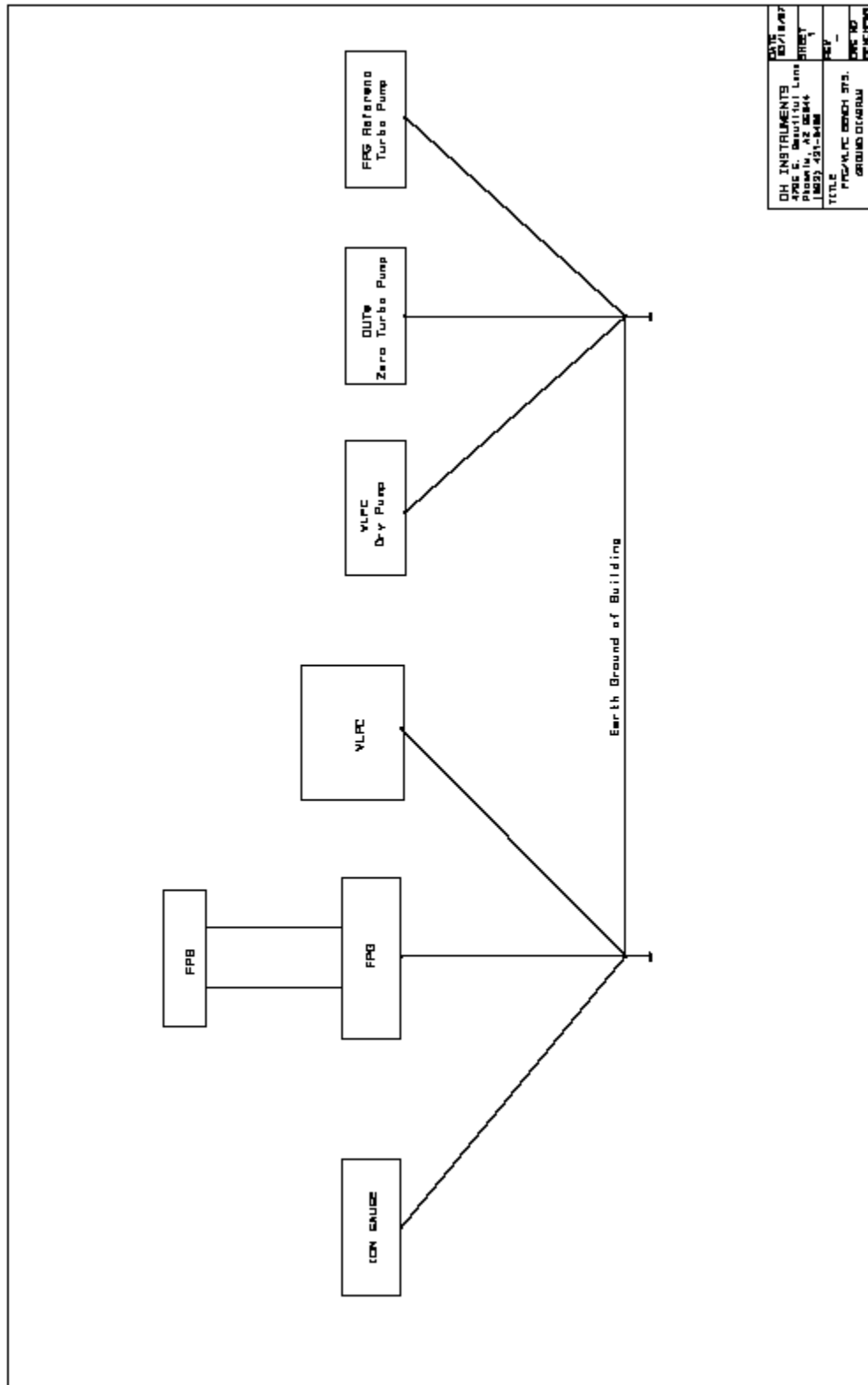

11.5.2 FPG GROUND DIAGRAM

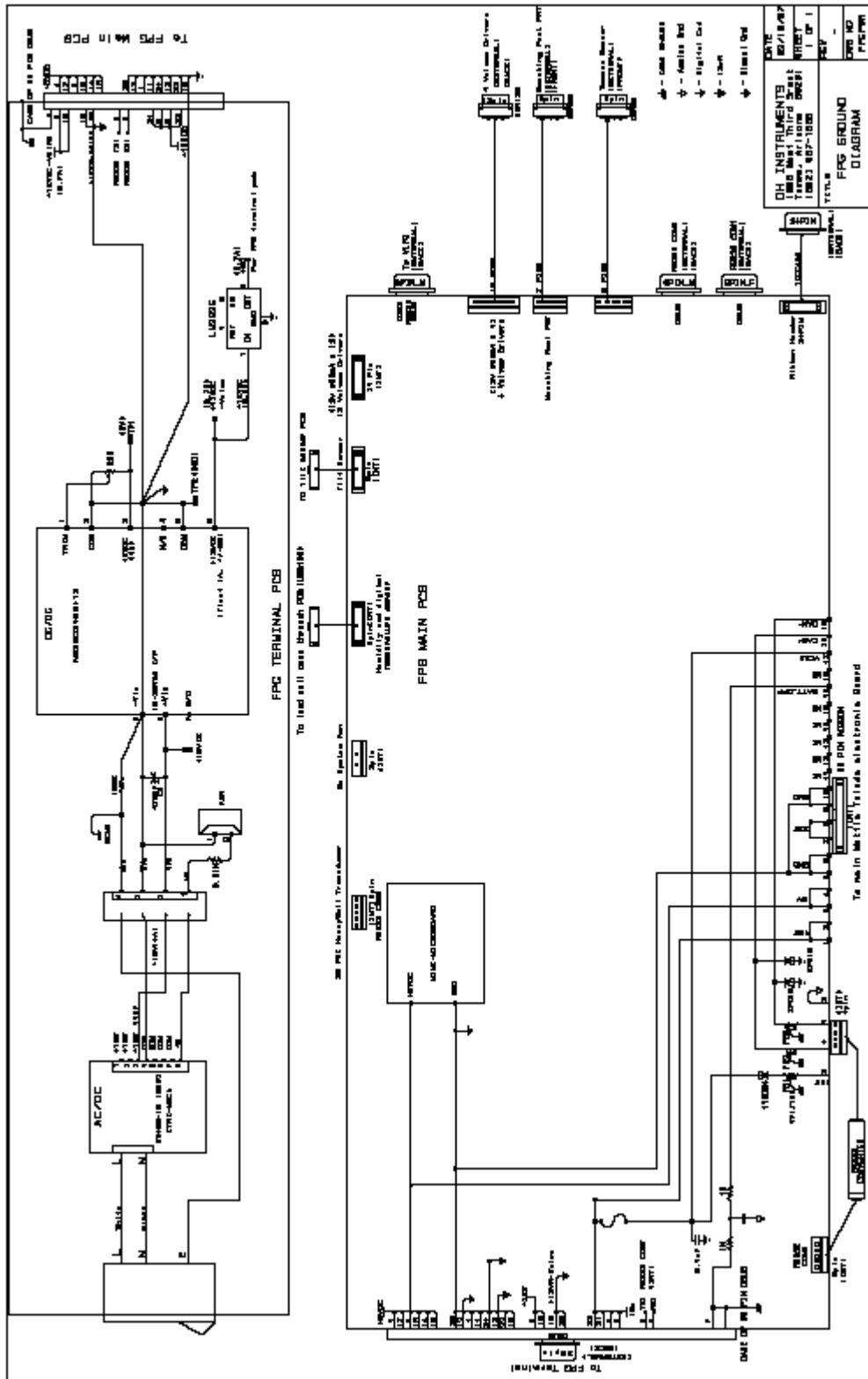

11.5.3 VLPC POWER DIAGRAM

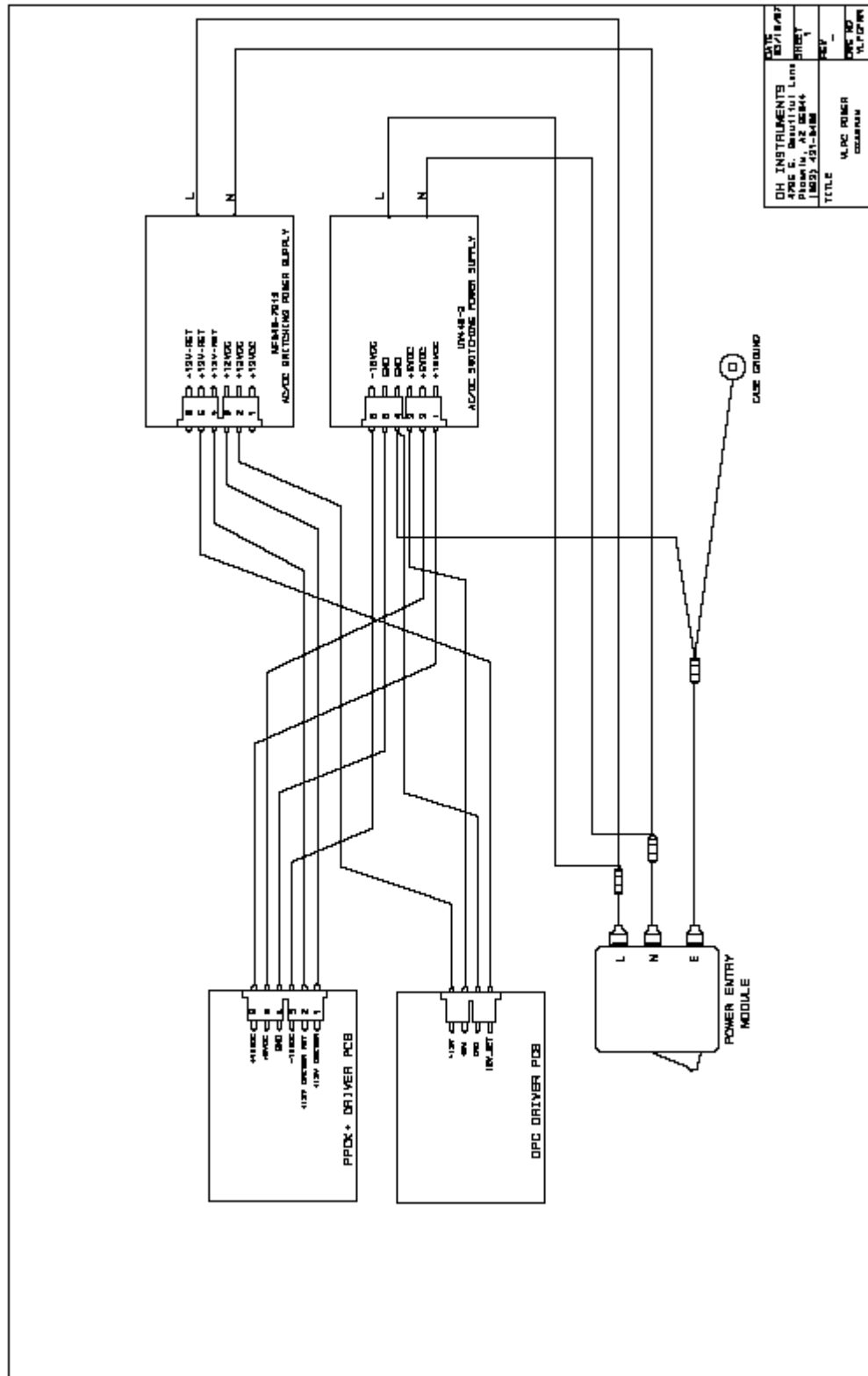



12. WARRANTY STATEMENT

Except to the extent limited or otherwise provided herein, **DH Instruments, a Fluke Company (DHI)** warrants for one year from purchase, each new product sold by it or one of its authorized distributors, only against defects in workmanship and/or materials under normal service and use. Products which have been changed or altered in any manner from their original design, or which are improperly or defectively installed, serviced or used are not covered by this warranty.

DHI and any of its Authorized Service Providers' obligations with respect to this warranty are limited to the repair or replacement of defective products after their inspection and verification of such defects. All products to be considered for repair or replacement are to be returned to **DHI**, or its Authorized Service Provider, freight prepaid, after receiving authorization from **DHI** or its Authorized Service Provider. The buyer assumes all liability vis-à-vis third parties in respect of its acts or omissions involving use of the products. In no event shall **DHI** be liable to purchaser for any unforeseeable or indirect damage, it being expressly stated that, for the purpose of this warranty, such indirect damage includes, but is not limited to, loss of production, profits, revenue, or goodwill, even if **DHI** has been advised of the possibility thereof, and regardless of whether such products are used individually or as components in other products.

Items returned to **DHI** under warranty claim but determined to not have a defect covered under warranty or to not have a defect at all are subject to an evaluation and shipping charge as well as applicable repair and/or calibration costs.

The provisions of this warranty and limitation may not be modified in any respect except in writing signed by a duly authorized officer of **DHI**.

The above warranty and the obligations and liability of **DHI** and its authorized service providers exclude any other warranties or liabilities of any kind.

Table 53. DHI Authorized Service Providers

DH INSTRUMENTS, A FLUKE COMPANY AUTHORIZED SERVICE PROVIDERS			
COMPANY	ADDRESS	TELEPHONE, FAX & EMAIL	NORMAL SUPPORT REGION
DH Instruments, a Fluke Company	4765 East Beautiful Lane Phoenix AZ 85044-5318 USA	Tel 602.431.9100 Fax 602.431.9559 cal.repair@dhinstruments.com	Worldwide
Minerva Meettechniek B.V	Chrysantstraat 1 3812 WX Amersfoort the NETHERLANDS	Tel (+31) 33.46.22.000 Fax (+31) 33.46.22.218 info@minervaipm.com	European Union
Ohte Giken Inc Technology Center	258-1, Nakadai Kasumigaura-machi, Niihari-Gun, Ibaraki 300-0133	Tel 81/29.840.9111 Fax 81/29.840.9100 tech@ohtegiken.co.jp	Japan/Asia
DH Products Technical Services Division	National Institute of Metrology (NIM) Pressure & Vacuum Lab, Heat Division No.308 SiKang Building, XiaoHuangZhuangLu HePingXiJie, ChaoYang District Beijing, 100013 PR CHINA	Tel 010.64291994 ext 5 Tel 010.64218637 ext 5 Fax 010.64218703 cxcen@mx.cei.gov.cn	Peoples Republic of China

NOTES



13. GLOSSARY

Absolute	As in absolute pressure . Pressure expressed relative to vacuum.
Absolute Differential	Differential pressure determined at near vacuum line pressure. The pressure expressed by the FPG when a vacuum reference device is not used in absolute mode.
Adder	A value added to internal sensor readings to offset the readings (pressure adder, temperature adder, humidity adder, vacuum adder) for calibration adjustment.
Ae	Piston-cylinder effective area.
Crossfloat	Process of comparison of two piston-cylinders in which they are connected together under pressure and the mass of one is adjusted so that both pistons float together at a common pressure. Used to set the line pressure in high line differential measurement mode.
Differential	As in differential pressure . Pressure expressed relative to a static pressure.
DUT (Device Under Test)	The device being tested or calibrated.
DUT Head	Fluid head correction to the pressure defined by the FPG8601 to predict the pressure at the level of the DUT which may be different from the FPG8601 reference level.
FS (&DUTFS)	The full scale value is the maximum value or the span of a measurement range. Limits and specifications are often expressed as % FS.
g, gl	Acceleration due to gravity (g). Acceleration due to gravity at location of use (gl).
Gauge	As in gauge pressure . Pressure expressed relative to atmospheric pressure.
Head	Fluid head, a pressure difference due to a difference in height. See also ATM head, DUT head and PISTON head.
HSTOP, LSTOP	High stop and low stop, piston maximum end of stroke positions.
InHg	Pressure unit of measure, inches of mercury.
InWa	Pressure unit of measure, inches of water.
kcm²	Pressure unit of measure, kilogram per centimeter square.
Line Pressure	Pressure relative to which the differential pressure is defined.
Measurement Mode	Mode in which FPG is defining pressures. These include gauge (pressure relative to atmospheric pressure), absolute by vacuum (pressure relative to absolute vacuum determined by establishing a vacuum in the reference port of the FPG), and absolute differential (pressure relative to atmospheric or another static pressure determined by subtracting the static pressure from absolute by vacuum).
Mass Bell	The sleeve loaded onto the piston to carry other masses.
Multiplier	A value by which internal sensor readings are multiplied to change their slope (pressure multiplier, temperature multiplier, humidity multiplier, vacuum multiplier) for calibration adjustment.
N2	Nitrogen gas.
Normal	A conventional or standard value.
PC	Piston-cylinder, piston-cylinder module.
PISTON Head	Fluid head correction based on the difference between the piston's current position and the reference level.
PRT	Platinum Resistance Thermometer. The element used in the piston-cylinder mounting post to measure temperature.
Ready/Not Ready	Indication of when conditions are present to make in tolerance pressure definitions based on specific criteria for each condition.
Reference Level	Height at which pressures are defined. The FPG8601 defines pressures at its reference level. Fluid head corrections correct the pressure relative to the reference level.
RPT	Reference pressure transducer.
Tare (Zero)	The process of setting the current forces on the FPG to zero.
True Mass	The actual mass of an object without the buoyancy effect of atmosphere.
User Level	Level of security that can be set to protect certain FPG functions from being accessed.

NOTES